

Terrain Q.



Design, specification and installation guide

1. The Genuit Group

At Genuit Group we help create a better built environment, by developing and producing sustainable solutions to the key challenges faced in water, climate and ventilation management. Sustainability is core to our commercial strategy, driving innovation in both how we run our business and the products we create. We find solutions for the environmental challenges facing our infrastructure, our buildings and our communities, and delivering these at scale.

The Genuit Group of businesses are recognised as professionals and experts in their given markets. From commercial and residential applications, heating and ventilation, fabrications, roads and highways to plumbing, large scale water storage and drainage, tall building applications and green infrastructure solutions. Our goal is to be the leading, UK-focused, sustainable products Group – helping construction build better.

Together, we aim to provide solutions to the sustainability and construction challenges of today and in the future. The increased need for resilient drainage systems, for example, the need for important Green Urbanisation, for cleaner, healthier air, for simpler, faster and more cost-effective drainage installations, for innovative future-ready systems and for low/zero-carbon heating and low-carbon construction.

Helping construction build better is at the heart of what we do. Through our sustainability strategy, the resilient way in which we operate, our capabilities and scalability, and our speed and agility through working together to understand exactly what you need to succeed.

It's an inclusive approach to business – and one our customers trust.



Polypipe Building Services



AT THE HEART OF COMMERCIAL AND TALL BUILDINGS.

At Polypipe Building Services, we harness our ingenuity and creativity to deliver class-leading solutions and product sustainability, with optimised whole-life costs, unrivalled technical support and on-the-ground assistance.



We understand the challenges today's projects face, including climate change, air quality and flooding, and in-industry regulations, skilled labour shortages and the lack of on-site storage facilities. From high-rise residential and commercial office projects to healthcare and leisure facilities, we develop systems that support you, that facilitate easier, more cost-effective ways to install.

Integral to our development process is providing innovative sustainable solutions that support safety, whether from the product itself or in the way it's installed. Our products are designed for a long life, use recycled content and are recyclable at end of life, enabling it to live on in the circular economy. We challenge ourselves on how we help solve on-site problems, whether lack of labour or on-site space, and look to develop solutions that benefit both the installing contractors and the occupants alike.



Polypipe Building Services, part of the Genuit Group. Helping construction build better.

MORE INNOVATION. MORE EXPERTISE. MORE SUPPORT.

Polypipe Building Services is always working to develop more exceptional products and more cost-effective ways to complete your project. For nearly 60 years, our Terrain brand has been the industry benchmark for drainage systems, but we offer so much more, including our award-winning water supply system MecFlow.

PRODUCTS AND SYSTEMS

Our specialism is tall buildings, so our products, systems and services reflect that, in design, performance and ease of installation. Our Terrain brand of products and systems have been no exception, from our benchmark, FUZE drainage stacks and PVC soil and waste systems, to the Terrain Q noise reducing system, P.A.P.A.® & Pleura Vent Systems and Firetraps.

However, our continued investment in new technologies and more innovative solutions, enables us to increase our category portfolio, including supply applications like MecFlow, which enables pre-fix installation via unique CLICKWELD technology before permanent electrofusion welding. We are constantly working to bring to market only the most sustainable, beneficial, and cost-effective products and systems – engineered from the most practical, recycled and recyclable materials. Together with our Advantage Service, fabrication capabilities and customer support, you're never left without a solution – whatever the challenge. Contact our sales team to discover more at commercial.buildingservices@polypipe.com

TECHNICAL

All our products and systems are backed by our hands-on technical team, providing expert support to ensure you receive a system that's right for your project. Whether it's a single component, or a fully fabricated system, you can call upon our specialist advice, and rely on us to deliver exactly what you need.

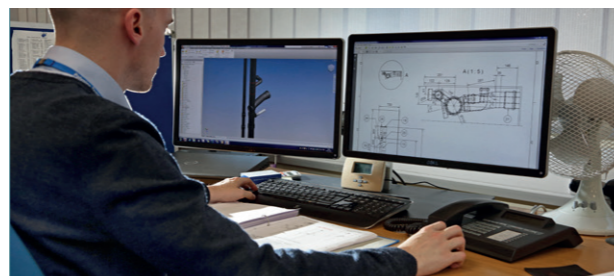

POLYPIPE ADVANTAGE SERVICE

We're constantly working and investing to discover new products and systems that take the complexities out of construction. And we apply that philosophy to ease of installation. Our Polypipe Advantage Service has been specifically introduced to make everything simple from beginning to end. From the design and planning of your project, to ordering, delivery, technical support, and customer service. Through Polypipe Advantage, our drainage stack systems and MecFlow supply systems can be fabricated to your own specification; created off-site, and delivered as a full, ready-to-install system on-site. Facilitating a faster installation process, whilst addressing skilled labour shortages and the lack of on-site storage facilities.

Welcome to Polypipe Building Services.
Delivering more, to achieve more.



Contents

SECTION 1	Welcome to Polypipe	Page
	The Genuit Group	2
	Polypipe Building Services	3 - 4
	Contents	5
SECTION 2	Introducing Terrain Q	
	Introducing Terrain Q and Features and Benefits	6 - 7
	The System and Technical Features	8 - 9
SECTION 3	Sound Protection	
	The Noise	10 - 11
	Acoustic Testing and System Design	12 - 13
SECTION 4	Terrain Q Pipe and Fittings	
	Pipes, Double Depth Socket, Slip Coupler and Double Depth Socket	14 - 15
	Bends and Double Socket Bend	16 - 17
	Branches	18 - 19
	Access Pipe, Reducers and Socket Plug	20 - 21
	Complementary PVC Fittings	22 - 23
SECTION 5	Chemical Resistance	
	Chemical Resistance Tables	24 - 33
SECTION 6	Polypipe Advantage, Storage and Handling	
	Polypipe Advantage	34
	Storage and Handling	35
SECTION 7	Installation	
	Design Considerations and general Notes	36 - 37
	Thermal Expansion and Vertical Push-fit System	38 - 39
	Horizontal Expansion System	40 - 41
	Acoustic Installation Guidance and Managing Sounds	42 - 43
	Branch Pipe Sizing	44 - 45
	Site Work Instructions and Information Tables	46 - 47
SECTION 8	Fire Sleeves and Collars	
	Fire Sleeves	48 - 49
SECTION 9	System Testing and Maintenance	
	System Testing and Maintenance	50 - 53
SECTION 10	System Specification	
	System Specification Overview	54 - 55
SECTION 11	Support	
	Support	56 - 57
SECTION 12	Approvals and Terms & Conditions	
	Approvals and Terms & Conditions	58 - 61

2. Introducing TERRAIN Q



PUSH-FIT JOINTING METHOD

MINERAL REINFORCED CENTRAL LAYER*

B-s1, d0**
FIRE CLASSIFICATION

Terrain Q is a simple, reliable alternative to other traditional and noise reducing drainage systems, taking an already tried and tested material, and developing it to give you so much more.

'More' in terms of multi-layer material benefits. 'More' for its engineered designed fittings. And 'more' in achieving a fire classification rating of B-s1, d0**; making it ideal for multi-occupancy and tall building projects.

* Mineral reinforced central layer, providing high stability to shock and vibrations making it an excellent choice for its noise reducing properties

**Fire classification rating B-s1, d0 according to EN13501, Terrain Q to be installed in accordance with building regulations. Where required we recommend Terrain Q is installed with Terrain Firetrap Sleeves.

Features and benefits

Terrain Q benefits your project more



CHEMICAL RESISTANCE

Terrain Q has excellent chemical resistance due to its high molecular weight and non-polar polymer structure. It is resistant to fluids from PH2-PH12.

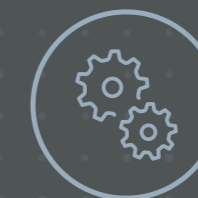

INCREASED MECHANICAL STRENGTH

Due to the addition of micro-fibres to the material formulation, Terrain Q has improved temperature characteristics giving it excellent mechanical strength over a range of fluid temperatures.



ANTI-FOULING

Terrain Q is manufactured using an anti-fouling additive within the internal bore. This helps to minimise encrustation build up, stopping sudden changes in flow direction which would increase noise.



PUSH-FIT JOINTING

Push fit joints provide the best of both worlds for a wide variety of drainage applications. In terms of installation, they're quick, easy and hassle-free.



LOW NOISE TRANSMISSION

Due to its material properties Terrain Q provides high resistance to the propagation of noise from water flowing at high velocities within its internal bore.



UV PROTECTION

The Terrain Q material formulation protects against oxidation by direct exposure to UV radiation from sunlight.



FIRE CLASSIFICATION

Terrain Q has the highest rating for an organic material when tested to BS EN 13501. It is a multi-layer polypropylene system to achieve the rating B-s1, d0 when tested in accordance with the standard. Irrespective of this fire resistance, Terrain Q shall be installed in accordance with approved document Building Regulation B at all times.



ABRASION RESISTANCE

The smooth and mechanically robust bore of Terrain Q protects against material erosion due to the flow of aggressive fluids over long periods of time.



EASY HANDLING

The Terrain Q system is more light in weight than traditional materials, making it an obvious choice due to ease of installation and handling.

The system

Noise-reducing drainage system B-s1, d0

Terrain Q is a new pipe system especially developed to be applied within the structure of multi-occupancy buildings. It is manufactured with the latest generation of multi-layer polypropylene, manufactured to the 495.4.5 dimensional requirements of BS EN 1451 Plastics piping systems for soil and waste drainage (low and high temperature) within the building structure - Polypropylene (PP).

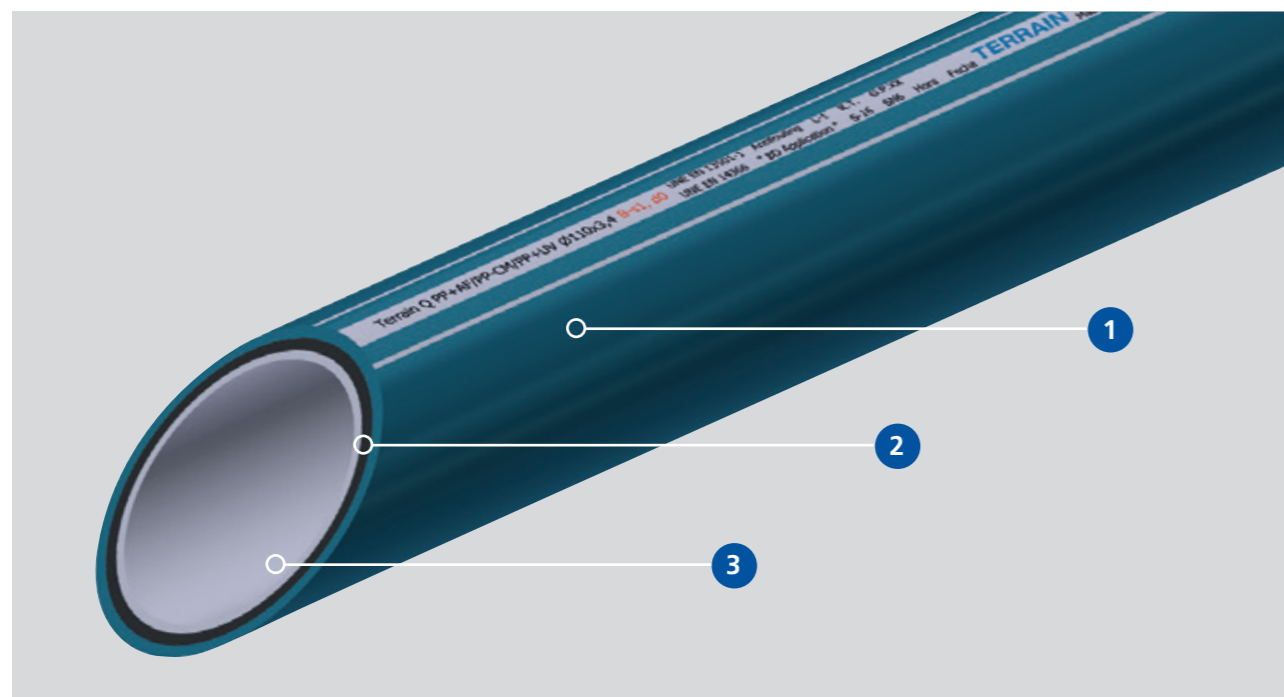

Terrain Q stands out for its high resistance to fire, rated B-s1, d0 according to the European standard EN 13501 and for its excellent sound absorbing properties, according to the data provided by the Fraunhofer Institute for Building Physics IBP.

This, coupled with its ease of installation thanks to the push-fit jointing method, its compatibility with other systems and fittings, make Terrain Q an ideal choice for projects that need noise reducing drainage systems.

Terrain Q has a wide range of pipes and fittings, from 40mm to 200mm diameter, making it an ideal solution for the installation of a complete drainage system.

TERRAIN MULTI-LAYER TECHNOLOGY

1. Blue external layer (RAL 5001) made of PP+UV+RF with white stripes (RAL 9003). The tough protective shell of the pipe, with UV protection. Sturdy and highly impact resistance.
2. Black intermediate layer (RAL 9004) made of PP+CM+RF. Mineral-reinforced plastic. Provided high stability and establishes the superior noise-reducing effect. There is also a fire retardant additive incorporated within this layer.
3. White internal layer (RAL 9003) made of PP+AF. Resistant to high temperatures (up to 97°C) chemical and abrasion resistance. Surface smoothness due to an anti-fouling additive, stopping build up of encrustations, which can increase noise.

Technical features

Terrain Q- Polypropylene pipe

Terrain Q is made of PP multi-layers for soil and waste water drainage, with fire classification B-s1, d0. The external layer has UV protection and the internal layer includes anti-fouling protection.

TECHNICAL SPECIFICATIONS			
PROPERTIES	TEST METHOD	TYPICAL VALUE	UNIT
Density	ISO 1183	>1200	kg/m ³
Ring rigidity	EN 9969	>4	SN
Ring flexibility	EN 1446	Without failure	-
Resistance to impact (round-the-lock method)	EN 744	TIR ≤10%	-
Water tightness (0,5 bar, 1 min)	EN 1053	Leak proof	-
Air tightness	EN 1054	Leak proof	-
High temperature cycle	EN 1055	Leak proof	-
Resistance to impact	EN 1411	H50 > 1m	-
Joint tightness with joint of plastic tightness	EN 1277	Leak proof	-
Fire classification	EN 13501	B-s1,d0	-
Halogen components	Halogen free	-	-

Table 2.01

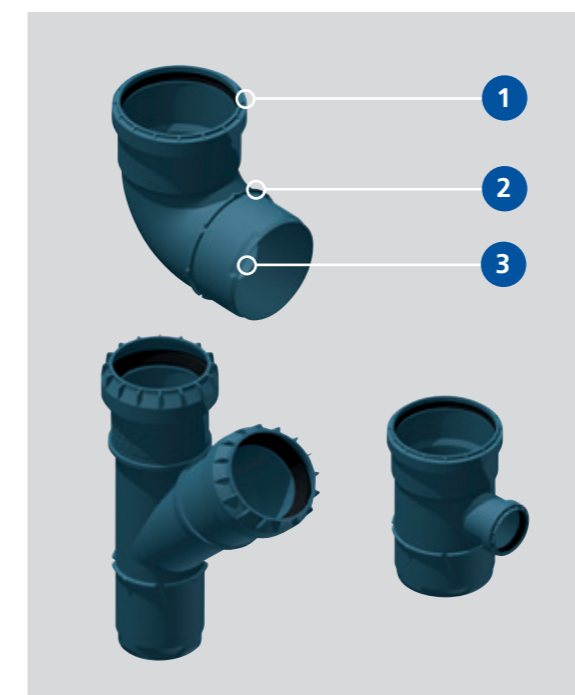

ADDITIONAL FEATURES TO AID INSTALLATION

1. Angle markings at 22.5 degrees
2. Insert stopper
3. Relief to assist insertion

“Terrain Q combines its excellent noise reducing properties with its high fire retardancy, making it an ideal choice for all your drainage requirements.”

3. Sound Protection

The following section references The Sound Transmission Inside Building Publication by The British Plastic Federation.

Noise from wastewater flow when it travels through a building can be an annoyance. This is unpleasant in all homes but particularly intrusive in multi-occupancy residential and commercial properties.

Example of buildings where sound attenuation is often specified:

- Shared dwellings
- Office buildings
- Multi-storey apartments
- Schools and universities
- Hotels
- Retail outlets
- Hospitals and care facilities

As noise continues to increase inherently from our 24/7 lives, clients and specifiers are seeking to minimise avoidable noise by soundproofing buildings. The ability to engineer plastic pipes through material and construction choices means that they can be designed to absorb both airborne and structure-borne sound. This makes them ideally suited to the transport of wastewater through a building.

SOUND TRANSMISSION IN BUILDINGS

Noise can be transferred through the air (airborne) or through the building fabric (structure-borne). A person's sensitivity to noise, when above the hearing threshold, will depend on the source and the location. For example, the acceptable sound level at a rock concert which you have chosen to attend is very different to the level tolerated when trying to sleep in a noisy hotel or relaxing in a quiet country location.



Airborne noise



Structure-borne noise

MAXIMUM ACCEPTABLE NOISE IN BUILDING

Recommended maximum sound levels in residential buildings vary by country, with an absolute sound pressure level of 30dB(A) being generally accepted as the maximum in rooms requiring sound insulation, for example living rooms and bedrooms.

This absolute value is measured against a fixed reference point (i.e. threshold of hearing) and takes into account all noise from building services including wastewater running through pipes. However, a range of requirements may be seen across projects as the value is not well defined. As buildings become quieter due to improvements in insulation products and practice, so the noise from building services is more noticeable and the requirements for noise reduction more stringent.

In the UK, the Building Regulations (2010) Approved Document E - Resistance to the passage of sound provides guidance on noise levels to be achieved within both domestic and commercial properties.

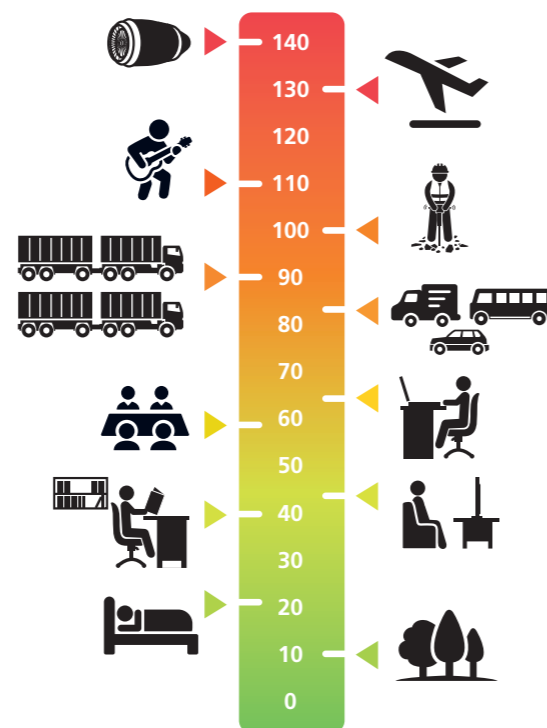

NOISE FROM WASTEWATER

Soil and waste systems inside buildings have the potential to contribute to noises inside a property and to an adjoining property.

- Airborne noise – generated by wastewater flowing inside the pipes.
- Structure-borne noise – generated by vibration (acoustic resonance) of the pipe as the sound waves generated by the wastewater transmitted through the pipe wall, pipe clips and brackets to the building structure.

Both sources of noise can be managed by good system design, product choice and correct installation. To further reduce sound transmission pipe wrapping materials, typically mineral wool should be used. Pipes should be enclosed to their full height. For full guidelines please refer to Section 7, Installation.

REDUCING AIRBORNE NOISE

The multi-layer construction of the Terrain Q piping system is specifically designed to reduce the transmission of noise vibration through the pipe wall as it propagates from the internal bore surface to the outside surface.

Starting at the internal layer Terrain Q has a smooth bore which includes anti-fouling additives reducing the risk of build-up which would disrupt the flow and increase airborne noise. The intermediate layer of Terrain Q is mineral reinforced which plays a key role with high stability and excellent absorption in reducing the transmission of noise.

The external layer of Terrain Q is a tough protected shell that reflects sound waves into the layer boundaries.

REDUCING STRUCTURE-BORNE NOISE

The best acoustic performance is achieved by preventing structure-borne sound. Good design is important, that's why Terrain Q is the obvious choice with a 20dB rating at 4l/s.

Terrain Q fittings are manufactured using the same mineral reinforced plastic that is in the intermediate layer of the pipe giving high stability and excellent absorption against shocks and vibrations. Coupled with a ring seal jointing method Terrain Q gives you a fantastic noise reducing piping system.

Together with Terrain Q it is essential the system is installed to best practice methods including the right sound dampening bracketry, fire protection and insulation. For full guidelines please refer to the installation section.

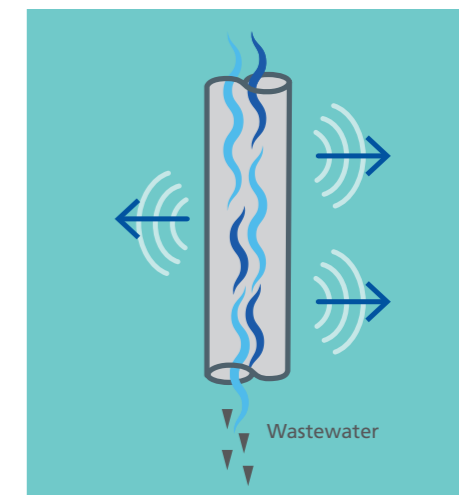

Airborne noise

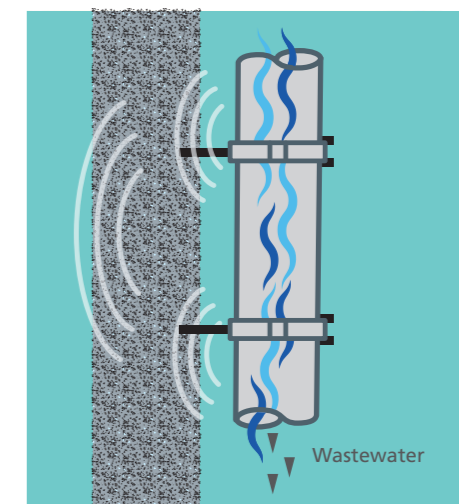

Structure-borne noise

Acoustic testing

Terrain Q has been tested by the Fraunhofer Institute for Building Physics (IBP) in Stuttgart, Germany to the standard BS EN 14366 'Laboratory measurement of noise from wastewater installations.'

BS EN 14366 establishes methods for measuring sound arising from wastewater installations under laboratory conditions. Whilst this is a large-scale test set-up which reflects a wastewater system inside a building, it is a repeatable set-up to allow comparison of products, materials and system components and will not reflect the actual conditions for any individual project.

The first test conducted gives the value for installation sound pressure levels generated for the system as installed in the test set-up. This value is the contribution of the wastewater running through the pipes towards the overall noise from the building services.

Using a series of specified test points, frequency spectra for airborne and structure-borne sound are determined individually to help the consultant address specific requirements for the building.

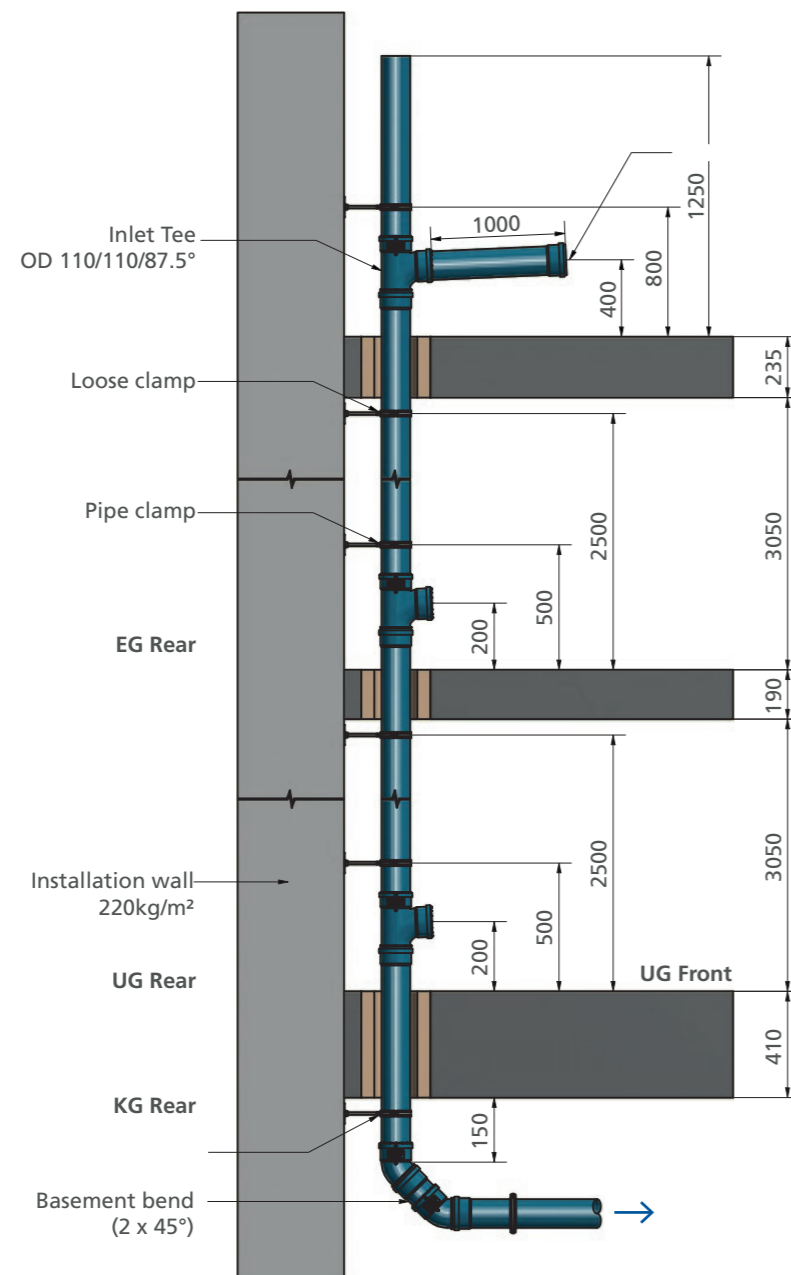

System design

Design of all sanitary pipework should be carried out in accordance with EN 12056 Parts 1, 2 and 5 which covers all aspects of sanitary pipework design and installation. To improve the acoustic performance of the drainage system, the system design should seek to minimise turbulence and also the creation of bubbles which impact on the pipe wall.

Take care with the following:

- To optimise the flow of wastewater, use smooth wall pipes.
- Avoid sudden changes in speed of wastewater i.e. rapid changes in pipe diameter.
- Avoid abrupt changes in direction to promote free flow - this can be achieved in the change from vertical to horizontal by using 2 x 45° bends, creating a 200mm long radius bend.
- Use sound-absorbing / dampening brackets which are dimensionally compatible with the acoustic pipe. These are full circle brackets with rubber inserts which insulate the system from structure-borne sound. (Note: Insert strips of soft PVC are not acceptable).
- Sound dampening brackets should allow for the control of thermal movement.
- Avoid contact between the pipe and the building structure i.e. floor/wall/ceiling by installing an insulation layer in the penetration hole before 'making good' the hole.

The following points are referenced from Building Regulations Part E.

- Pipes that penetrate the floor separating habitable rooms in different apartments should be enclosed to their full height.
- The enclosure should be constructed of a material having a mass per unit area of at least 15kg/m². Either line the enclosure or wrap the pipe with 25mm unfaced mineral fibre.
- Pipe penetrations through a separate floor should have fire protection to satisfy Building Regulation Part B – Fire Safety. Fire stopping should be flexible and prevent rigid contact between the pipe and floor.



4. Terrain Q Pipe and Fittings

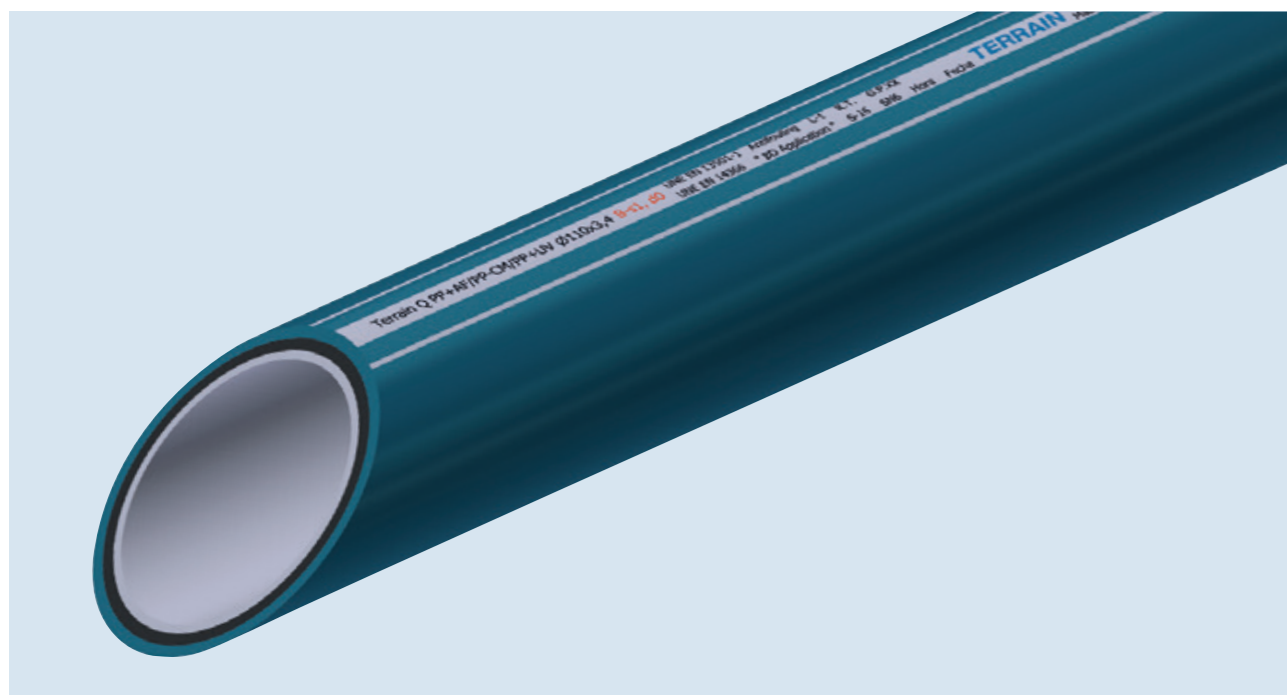

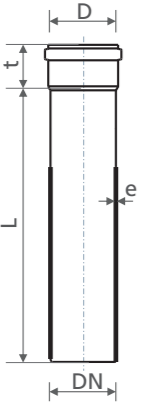

Terrain Q Fittings – Single socket pipe

SINGLE SOCKET PIPE							
PRODUCT	CODE	DN mm	L mm	THICKNESS mm	t mm	D mm	WEIGHT Kg/un.
	700P.40.30B	40	3000	1.8	45	55	0.710
	700P.50.30B	50	3000	1.8	47	63	0.899
	700P.75.30B	75	3000	1.9	53	89	1.448
	700P.110.30B	110	3000	2.7	62	128	3.095
	700P.160.30B	160	3000	3.9	77	184	6.629
	700P.200.30B	200	3000	4.9	122	226	10.630

Terrain Q Fittings – Double depth socket Slip coupler Double socket

DOUBLE DEPTH SOCKET					
PRODUCT	CODE	LENGTH mm	HEIGHT mm	WIDTH mm	WEIGHT Kg/un.
	711P.50B	63	174	63	0.07
	711P.110B	127	243	127	0.37

SLIP COUPLER				
PRODUCT	CODE	DN mm	L mm	WEIGHT Kg/un.
	711P.S.40B	40	96	0.04
	711P.S.50B	50	93	0.05
	711P.S.75B	75	103	0.13
	711P.S.110B	110	145	0.28
	711P.S.160B	160	180	0.68
	711P.S.200B	200	240	1.50

DOUBLE SOCKET				
PRODUCT	CODE	DN mm	L mm	WEIGHT Kg/un.
	710P.40B	40	92	0.04
	710P.50B	50	94	0.05
	710P.75B	75	105	0.09
	710P.110B	110	145	0.28
	710P.160B	160	180	0.68
	710P.200B	200	240	1.50

Terrain Q Fittings – Bends

BENDS						
PRODUCT	CODE	DN mm	L mm	Z1 mm	Z2 mm	WEIGHT Kg/un.
15° Bend 	707P.110.165B	110	80	13	13	0.28
30° Bend 	707P.110.150B	110	88	21	20	0.28
45° Bend 	707P.40.135B	40	57	13	14	0.03
	707P.50.135B	50	63	15	16	0.04
	707P.75.135B	75	75	21	21	0.13
	707P.110.135B	110	96	29	29	0.30
	707P.160.135B	160	122	37	41	0.84
	707P.200.135B	200	159	41	52	1.85
87° Bend 	707P.40.92B	40	68	24	25	0.04
	707P.50.92B	50	78	29	30	0.05
	707P.75.92B	75	97	42	42	0.15
	707P.110.92B	110	128	60	60	0.30
	707P.160.92B	160	169	84	87	0.98
	707P.200.92B	200	230	106	115	2.36

Terrain Q Fittings – Double socket bend

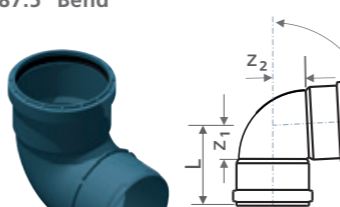
DOUBLE SOCKET BEND						
PRODUCT	CODE	DN mm	L mm	Z1 mm	Z2 mm	WEIGHT Kg/un.
45° Bend 	701P.110.135B	110	97.8	32.8	32.8	0.33
87.5° Bend 	701P.110.92B	110	128	53	53	0.40

Terrain Q Fittings – Single branch
Single reducing branch

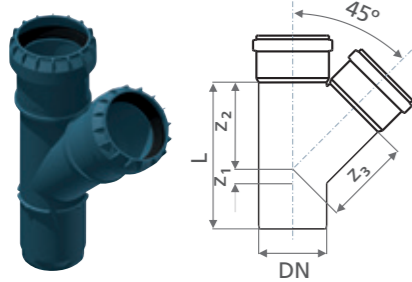
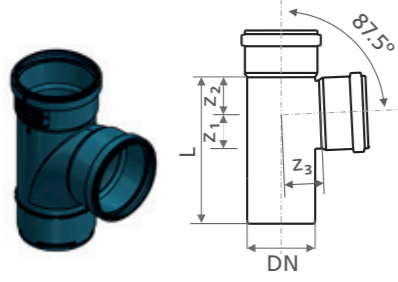
SINGLE BRANCH							
PRODUCT	CODE	DN mm	L mm	Z1 mm	Z2 mm	Z3 mm	WEIGHT Kg/un.
45° Branch 	704P.40.135B	40	111	13	54	54	0.08
	704P.50.135B	50	129	15	66	66	0.11
	704P.75.135B	75	173	21	98	98	0.28
	704P.110.135B	110	240	29	144	144	0.54
	704P.160.135B	160	329	35	209	209	1.83
	704P.200.135B	200	416	52	240	240	4.00
87.5° Branch 	704P.40.92B	40	94	24	25	25	0.07
	704P.50.92B	50	108	29	30	30	0.10
	704P.75.92B	75	142	42	45	45	0.23
	704P.110.92B	110	195	61	67	67	0.40
	704P.160.92B	160	310	115	118	118	1.62
	704P.200.92B	200	388	140	127	126	3.80

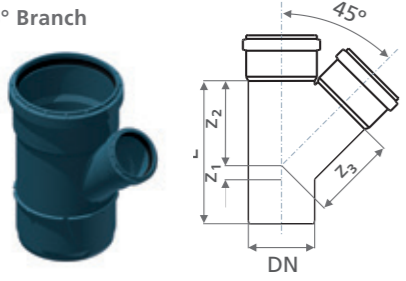
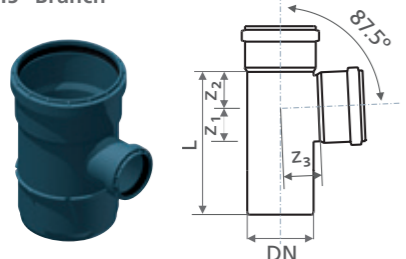
SINGLE REDUCING BRANCH							
PRODUCT	CODE	DN mm	L mm	Z1 mm	Z2 mm	Z3 mm	WEIGHT Kg/un.
45° Branch 	704P.7550.135B	75 - 50	138	3	80	84	0.20
	704P.11050.135B	110 - 50	153	-13	99	109	0.38
	704P.11075.135B	110 - 75	189	5	117	123	0.48
	704P.160110.135B	160 - 110	261	2	174	184	1.31
	704P.200160.135B	200 - 160	360	13	229	253	3.23
87.5° Branch 	704P.11050.92B	110 - 50	132	30	34	61	0.30
	704P.11075.92B	110 - 75	158	43	48	63	0.42
	704P.160110.92B	160 - 110	261	81	95	107	1.21

Terrain Q Fittings – Fully socketed branch
Double equal branch

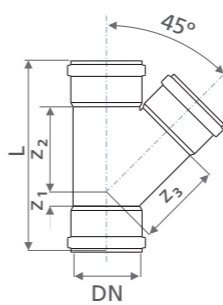
FULLY SOCKETED BRANCH							
PRODUCT	CODE	DN mm	L mm	Z1 mm	Z2 mm	Z3 mm	WEIGHT Kg/un.
45° Branch 	704E.110.135B	110	311	33	148	148	0.73

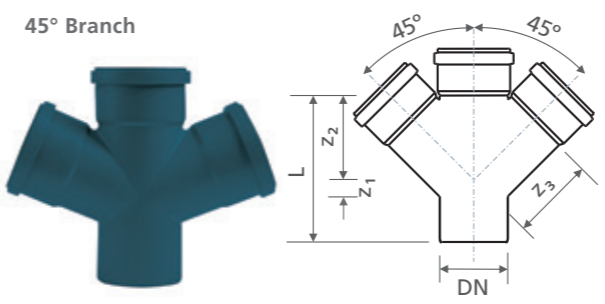
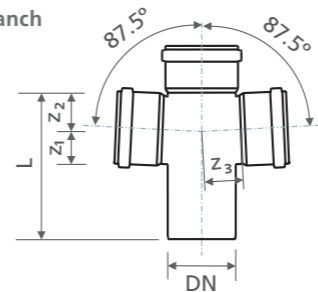
DOUBLE EQUAL BRANCH							
PRODUCT	CODE	DN mm	L mm	Z1 mm	Z2 mm	Z3 mm	WEIGHT Kg/un.
45° Branch 	706P.110.135B	110	243	29	147	145	0.89
87.5° Branch 	706P.110.90B	110	196	69	60	96	0.64

Terrain Q Fittings – Access pipe with cap Eccentric reducer

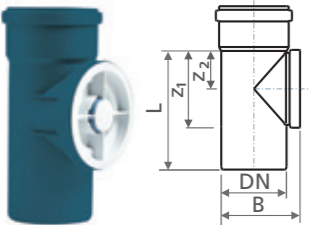
ACCESS PIPE WITH CAP							
PRODUCT	CODE	DN mm	L mm	Z1 mm	Z2 mm	B mm	WEIGHT Kg/un.
	738P.50.90B	50	116	68	33	63	0.09
	738P.75.90B	75	156	102	52	94	0.25
	738P.110.90B	110	205	144	76	138	0.62
	738P.160.90B	160	244	168	92	213	1.14
	738P.200.90B						0.37

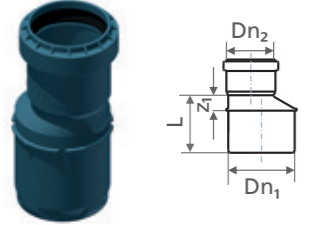
ECCENTRIC REDUCER						
PRODUCT	CODE	DN1 mm	DN2 mm	L mm	Z1 mm	WEIGHT Kg/un.
	723P.5040B	50	40	65	20	0.05
	723P.7550B	75	50	79	31	0.09
	723P.11050B	110	50	113	47	0.19
	723P.11075B	110	75	99	32	0.20
	723P.160110B	160	110	124	39	0.51
	723P.200160B	200	160	171	47	1.31

Terrain Q Fittings – Short eccentric reducer Socket plug

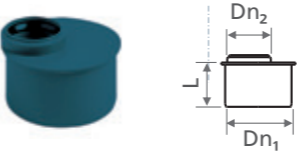
SHORT ECCENTRIC REDUCER					
PRODUCT	CODE	DN1 mm	DN2 mm	L mm	WEIGHT Kg/un.
	724P.7550B	75	50	55	0.05
	724P.11075B	110	75	62	0.14

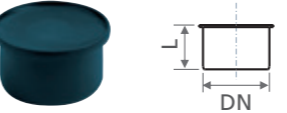
SOCKET PLUG				
PRODUCT	CODE	DN1 mm	L mm	WEIGHT Kg/un.
	730P.40B	40	40	0.02
	730P.50B	50	44	0.02
	730P.75B	75	51	0.06
	730P.110B	110	62	0.14
	730P.160B	160	92	0.36
	730P.200B	200	122	0.85

PVC Fittings to complement the system

Terrain Q Fittings – Corner boss branch
Double branch
Single branch spigot outlet

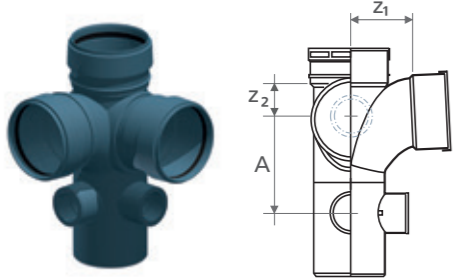
CORNER BOSS BRANCH - spigot outlet, 1 boss horn, 2 waste sockets							
PRODUCT	CODE	SIZE mm	ANGLE	A mm	Z1 mm	Z2 mm	WEIGHT Kg/un.
	706P.490.12B	110	92.5°	120	83	59	0.87

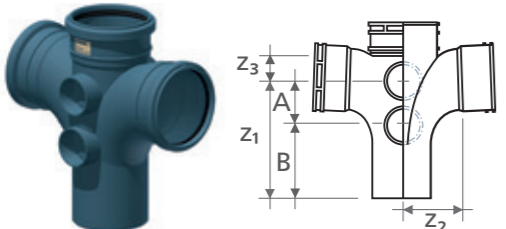
DOUBLE BRANCH - spigot outlet, 4 boss horns									
PRODUCT	CODE	SIZE mm	ANGLE	A mm	B mm	Z1 mm	Z2 mm	Z3 mm	WEIGHT Kg/un.
	706P.104.92B	110	92.5°	75	128	203	96	50	1.3

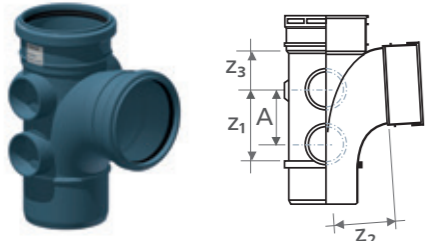
SINGLE BRANCH - spigot outlet, 5 boss horns								
PRODUCT	CODE	SIZE mm	ANGLE	A mm	Z1 mm	Z2 mm	Z3 mm	WEIGHT Kg/un.
	704P.104.92B	110	92.5°	74	103	96	50	0.8

Terrain Q Fittings – Four way bossed pipe connector
Universal soil manifold

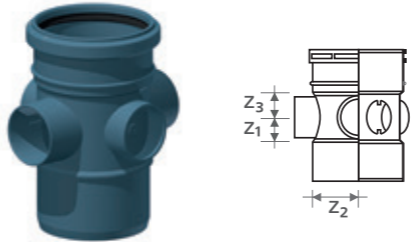
FOUR WAY BOSSED PIPE CONNECTOR						
PRODUCT	CODE	SIZE mm	Z1 mm	Z2 mm	Z3 mm	WEIGHT Kg/un.
	720P.412.2B	110/40	30	56	30	0.4

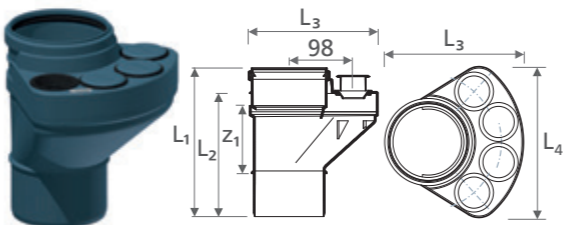
UNIVERSAL SOIL MANIFOLD - for solvent waste connections								
PRODUCT	CODE	SIZE mm	L1 mm	L2 mm	L3 mm	L4 mm	Z1 mm	WEIGHT Kg/un.
	719P.412.15B	110	228	189	199	217	105	0.69

For connection of BS 5254/BS 5255 40mm waste pipes at floor level. Incorporates 4 inlets to accept 40mm waste pipes without need for adaptors. Use with Swivel Elbow or Swept Bend.

5. Chemical Resistance

The use of thermoplastic pipe systems within the commercial market is now widespread. Thermoplastics have replaced traditional materials such as steel, ductile iron and copper. Because of this diversity of use, it is essential that the most suitable plastic material is matched to its proposed application.

This section will provide a guide to compatible material selection. The information within this section has been collated from tests carried out by both national and international standards organisations (ISO/TR10358:1993) as well as tests performed by independent test houses.

The tests were based on the use of pure chemicals. For mixed chemicals, we would advise that pilot tests should be undertaken in order to ascertain the resistance of the material under these circumstances.

SEALS AND SEAT MATERIALS

The working life of seals and seat materials is often different from that of the pipe system and greatly dependent on the working conditions involved.

Tables 5.01 and 5.02 outline their resistance.

SEAL AND SEAT MATERIAL	
MATERIAL TYPE	RESISTANCE
EDPM-Ethylene Propylene Rubber	Satisfactory resistance to most aggressive chemicals, not suitable for oils or fat
FPM-Fluorine Rubber	The most resistant of the elastomers to solvents
NBR-Nitrile Rubber	Not resistant to oxidising agents, but resists petrol and oils
PTFE-Polytetrafluoroethylene	Resists all the chemicals shown in tables

Table 5.01

TERMINOLOGY FOR CHEMICAL RESISTANCE TABLES	
SYMBOL/TERM	DESCRIPTION
✓	Resistant
○	Conditionally resistant
×	Not recommended
-	No test data available
Technical grade	Technically pure
Saturated	Media has reached its maximum absorption in water at ambient temperature, which is the point where there can be no further absorption
Aqueous	A solution below maximum absorption, expressed as a percentage (%) of saturation (concentration)
Suspension	Insoluble or partially soluble solid carried in an aqueous base normally prepared at ambient temperature
Commercial Proprietary Industrial	Self explanatory, grades of chemical named brands in general use

Table 5.02

Chemical resistance – table 5.03

Terrain Q is made from PPR, please follow the column labeled Polypropylene.

CHEMICAL	CONCENTRATION	MATERIAL°C																		
		PVCu			ABS			PE			POLYPROPYLENE			EPDM			FPM			
		20	40	60	20	40	60	20	40	60	20	60	100	20	40	60	20	60	100	120
Acetaldehyde	40% aqueous solution	○	×	-	×	-	-	✓	✓	○	✓	○	○	✓	○	○	✓	○	-	-
Acetaldehyde	Technically pure	×	-	-	×	-	-	✓	○	-	○	×	-	✓	○	×	○	×	-	-
Acetic acid	50% Aqueous	✓	✓	○	×	-	-	✓	✓	✓	✓	✓	✓	✓	○	-	○	-	-	-
Acetic acid	Technically pure glacial	○	×	-	×	-	-	✓	✓	○	✓	✓	○	✓	○	-	×	-	-	-
Acetic acid anhydride	Technically pure	×	-	-	×	-	-	✓	○	-	✓	-	-	○	-	-	×	-	-	-
Acetic acid ethylester		×	-	-	×	-	-	✓	-	-	✓	-	-	✓	-	-	○	-	-	-
Acetic acid isobutyl ester	Technically pure	×	-	-	×	-	-	✓	-	-	✓	-	-	✓	-	-	×	-	-	-
Acetone	Up to 10% aqueous	×	-	-	○	-	-	✓	✓	✓	✓	✓	✓	✓	✓	✓	○	×	-	-
Acetone	Technically pure	×	-	-	×	-	-	✓	✓	✓	✓	✓	-	✓	✓	✓	×	-	-	-
Acetonitrile	100%	×	-	-	×	-	-	○	-	-	○	-	-	○	-	-	×	-	-	-
Acetophenone	100%	×	-	-	×	-	-	○	-	-	○	-	-	✓	-	-	×	-	-	-
Acrylic acid methyl ester	Technically pure	×	-	-	×	-	-	○	-	-	×	-	-	○	-	-	-	-	-	-
Acrylicethyl	Technically pure	×	-	-	×	-	-	○	-	-	×	-	-	○	-	-	×	-	-	-
Acrylonitrile	Technically pure	×	-	-	×	-	-	✓	✓	✓	✓	-	-	✓	✓	○	○	×	-	-
Adipic acid	Saturated, aqueous	✓	✓	×	×	-	-	✓	✓	✓	✓	✓	-	✓	✓	✓	✓	✓	-	-
Allyl alcohol	96%	○	×	-	×	-	-	✓	✓	✓	✓	○	-	✓	✓	○	○	-	-	-
Ammonia	Gaseous technically pure	✓	✓	✓	×	-	-	✓	✓	✓	✓	✓	-	✓	-	-	✓	-	-	-
Ammonium acetate	Aqueous, all	✓	✓	○	○	-	-	✓	✓	✓	✓	✓	✓	✓	✓	✓	✓	✓	-	-
Ammoniumpersulphate		✓	✓	○	-	-	-	✓	-	-	○	-	-	✓	-	-	✓	-	-	-
Ammonium salts, aqueous inorganic	Saturated	✓	✓	✓	-	-	-	✓	✓	✓	✓	✓	-	✓	✓	✓	✓	✓	-	-
Amyl acetate	Technically pure	×	-	-	×	-	-	✓	✓	✓	○	×	-	○	-	-	×	-	-	-
Amyl alcohol	Technically pure	✓	✓	○	×	-	-	✓	✓	✓	✓	✓	-	✓	✓	✓	○	-	-	-
Aniline	Technically pure	×	-	-	×	-	-	✓	○	-	✓	○	-	✓	✓	✓	○	○	-	-
Antimony trichloride	90% Aqueous	✓	✓	-	×	-	-	✓	✓	✓	✓	✓	-	✓	-	-	✓	-	-	-
Aqua regia	Mixing ratio	✓	○	-	×	-	-	×	-	-	×	-	-	×	-	-	○	-	-	-
Arsenic acid	80% Aqueous	✓	✓	○	✓	✓	✓	✓	✓	✓	✓	✓	-	✓	✓	✓	✓	✓	✓	-
Barium salts, aqueous inorganic	Saturated	✓	✓	✓	✓	-	-	✓	✓	✓	✓	✓	-	✓	✓	✓	✓	✓	✓	-
Beer	Usual commercial	✓	-	-	✓	-	-	✓	-	-	✓	-	-	-	-	-	✓	-	-	-
Benzaldehyde	Saturated, aqueous	×	-	-	×	-	-	✓	✓	○	✓	-	-	✓	✓	○	✓	✓	-	-
Benzene	Technically pure	×	-	-	×	-	-	○	○	-	○	-	-	×	-	-	✓	-	-	-
Benzene sulfonic acid	Technically pure	✓	-	-	-	-	-	✓	✓	○	✓	○	-	✓	✓	○	✓	-	-	-

KEY: – NO DATA × NOT RECOMMENDED ○ CONDITIONALLY RESISTANT ✓ RESISTANT

The information in these tables has been supplied by other reputable sources and is to be used ONLY as a guide in selecting equipment for appropriate chemical compatibility. Before permanent installation, test the equipment with the chemicals and under the specific conditions of your application. Ratings of chemical behaviour listed in this chart apply to a 48-hr exposure period, we have no knowledge of possible effects beyond this period. We do not warrant (neither express or implied) that the information in this chart is accurate or complete or that any material is suitable for any purpose.

Chemical resistance – table 5.04

Terrain Q is made from PPR, please follow the column labeled Polypropylene.

CHEMICAL	CONCENTRATION	MATERIAL°C																		
		PVCu			ABS			PE			POLYPROPYLENE			EPDM			FPM			
		20	40	60	20	40	60	20	40	60	20	60	100	20	40	60	20	60	100	120
Benzene (Gasoline)	Free of lead and aromatic compounds	✓	✓	-	×	-	-	✓	✓	-	○	-	-	×	-	-	✓	-	-	-
Benzoic acid	Aqueous, all	✓	✓	○	✓	✓	-	✓	✓	✓	✓	✓	✓	✓	-	✓	✓	○	-	
Benzyl alcohol	Technically pure	○	-	-	×	-	-	✓	✓	○	✓	○	-	✓	✓	○	✓	-	-	-
Beryllium salts, aqueous, inorganic		✓	✓	✓	-	-	-	✓	✓	✓	✓	✓	-	✓	✓	✓	✓	✓	-	-
Borax	Aqueous, all	✓	✓	○	✓	✓	-	✓	✓	✓	✓	✓	✓	✓	✓	✓	✓	✓	-	-
Boric acid	Aqueous, all	✓	✓	○	✓	✓	✓	✓	✓	✓	✓	✓	✓	✓	✓	✓	✓	✓	-	-
Bromine water	Saturated, aqueous	✓	-	-	×	-	-	×	-	-	×	-	-	×	-	-	✓	-	-	-
Butadiene	Technically pure	✓	-	-	×	-	-	○	-	-	○	-	-	×	-	-	✓	-	-	-
Butane	Technically pure	✓	-	-	✓	-	-	✓	-	-	✓	-	-	×	-	-	✓	-	-	-
Butanediol	10% Aqueous	✓	○	-	×	-	-	✓	✓	✓	✓	✓	-	✓	✓	✓	✓	✓	-	-
Butanol	Technically pure	✓	✓	○	×	-	-	✓	✓	✓	✓	○	-	✓	✓	✓	✓	×	-	-
Butyl acetate	Technically pure	×	-	-	×	-	-	✓	-	-	○	-	-	✓	×	-	○	-	-	-
Butyl phenol p-tertiary	Technically pure	○	×	-	×	-	-	○	-	-	✓	-	-	×	-	-	○	-	-	-
Butylene glycol	Technically pure	✓	✓	○	-	-	-	✓	✓	✓	✓	✓	-	✓	✓	✓	✓	○	-	-
Butylene liquid	Technically pure	✓	-	-	-	-	-	×	-	-	×	-	-	○	-	-	✓	-	-	-
Butyric acid	Technically pure	✓	-	-	×	-	-	✓	-	-	✓	-	-	○	-	-	○	-	-	-
Caesium salts, aqueous inorganic	<Saturated acid	✓	✓	✓	-	-	-	✓	✓	✓	✓	✓	-	✓	✓	✓	✓	✓	-	-
Cadmium salts, aqueous inorganic	<Saturated acid	✓	✓	✓	-	-	-	✓	✓	✓	✓	✓	-	✓	✓	✓	✓	✓	-	-
Calcium acetate	Saturated	✓	✓	✓	-	-	-	✓	✓	✓	✓	✓	-	✓	✓	✓	✓	✓	-	-
Calcium hydroxide	Saturated aqueous	✓	✓	✓	-	-	-	✓	✓	✓	✓	✓	-	✓	✓	✓	✓	✓	✓	-
Calcium lactate	Saturated	✓	✓	-	-	-	-	✓	✓	✓	✓	✓	-	✓	✓	✓	✓	✓	-	-
Calcium salts, aqueous, inorganic	Saturated acid	✓	✓	✓	✓	✓	-	✓	✓	✓	✓	✓	-	✓	✓	✓	✓	✓	-	-
Carbon dioxide	Technically pure, anhydrous	✓	✓	✓	-	-	-	✓	✓	✓	✓	✓	-	✓	✓	✓	✓	✓	-	-
Carbon tetrachloride	Technically pure	×	-	-	×	-	-	×	-	-	×	-	-	×	-	-	✓	-	-	-
Carbonic acid		✓	✓	✓	-	-	-	✓	✓	✓	✓	✓	-	✓	✓	✓	✓	✓	-	-
Caro's acid		✓	-	-	-	-	-	-	-	-	-	-	-	-	-	-	✓	-	-	-
Caustic potash solution (potassium hydroxide)	50% Aqueous	✓	✓	○	-	-	-	✓	✓	✓	✓	○	-	✓	✓	✓	×	-	-	-
caustic soda solution	50% Aqueous	✓	✓	✓	-	-	-	✓	✓	✓	✓	○	-	✓	✓	✓	×	-	-	-
Chloric acid	10% Aqueous	✓	✓	○	×	-	-	✓	✓	-	×	-	-	✓	✓	✓	✓	✓	-	-
Chloric acid	20% Aqueous	✓	✓	○	×	-	-	○	-	-	×	-	-	○	○	-	✓	✓	-	-
Chlorine	Moist, 97% gaseous	×	-	-	×	-	-	×	-	-	×	-	-	×	-	-	✓	-	-	-

KEY: – NO DATA × NOT RECOMMENDED ○ CONDITIONALLY RESISTANT ✓ RESISTANT

The information in these tables has been supplied by other reputable sources and is to be used ONLY as a guide in selecting equipment for appropriate chemical compatibility. Before permanent installation, test the equipment with the chemicals and under the specific conditions of your application. Ratings of chemical behaviour listed in this chart apply to a 48-hr exposure period, we have no knowledge of possible effects beyond this period. We do not warrant (neither express or implied) that the information in this chart is accurate or complete or that any material is suitable for any purpose.

Chemical resistance – table 5.05

Terrain Q is made from PPR, please follow the column labeled Polypropylene.

CHEMICAL	CONCENTRATION	MATERIAL°C																		
		PVCu			ABS			PE			POLYPROPYLENE			EPDM			FPM			
		20	40	60	20	40	60	20	40	60	20	60	100	20	40	60	20	60	100	120
Chlorine	Liquid, technically pure, as double pipe system	×	-	-	×	-	-	×	-	-	×	-	-	×	-	-	○	-	-	-
Chlorine	Anhydrous, technically pure, as double pipe system	×	-	-	×	-	-	○	○	-	×	-	-	○	-	-	✓	-	-	-
Chlorine water	Saturated	✓	✓	○	○	-	-	○	○	-	○	-	-	○	-	-	✓	-	-	-
Chloroacetic acid, mono	50% Aqueous	✓	✓	-	×	-	-	✓	✓	○	✓	○	-	○	-	-	×	-	-	-
Chloroacetic acid, mono	Technically pure	✓	✓	○	×	-	-	✓	✓	○	✓	○	-	○	-	-	×	-	-	-
Chlorobenzene	Technically pure	×	-	-	×	-	-	○	-	-	○	-	-	×	-	-	×	-	-	-
Chloroethanol	Technically pure	×	-	-	×	-	-	✓	✓	✓	✓	✓	-	○	-	-	×	-	-	-
Chlorosulphonic acid	Technically pure	○	-	-	×	-	-	×	-	-	×	-	-	×	-	-	×	-	-	-
Chromic acid	Aqueous, all	○	○	-	×	-	-	○	-	-	○	-	-	-	-	-	✓	○	-	-
Chromic acid + water + sulphuric acid	50g 15g 35g	✓	✓	○	×	-	-	×	-	-	×	-	-	×	-	-	○	○	-	-
Chromium (II) - salts, aqueous, inorganic	<Saturated acid	✓	✓	✓	-	-	-	-	-	-	-	-	-	-	-	-	-	-	-	-
Compressed air, containing oil		×	-	-	×	-	-	✓	✓	-	○	-	-	×	-	-	✓	-	-	-
Copper salts, aqueous inorganic	<Saturated acid	✓	✓	○	✓	✓	✓	✓	✓	✓	✓	✓	-	✓	✓	-	✓	✓	-	-
Cresol	Cold saturated aqueous	○	-	-	×	-	-	✓	✓	○	✓	-	-	○	-	-	✓	-	-	-
Crotonic aldehyde	Technically pure	×	-	-	×	-	-	✓	-	-	✓	-	-	✓	-	-	✓	-	-	-
Cyclohexane	Technically pure	×	-	-	×	-	-	✓	✓	✓	✓	-	-	×	-	-	✓	-	-	-
Cyclohexanol	Technically pure	✓	✓	✓	×	-	-	✓	✓	✓	✓	○	-	×	-	-	✓	-	-	-
Cyclohexanone	Technically pure	×	-	-	×	-	-	✓	○	○	✓	○	-	○	-	-	×	-	-	-
Dextrine	Usual commercial	✓	✓	✓	✓	✓	✓	✓	✓	✓	✓	-	-	✓	✓	✓	✓	✓	-	-
Diisobutyl ketone	Technically pure	×	-	-	×	-	-	✓	○	-	✓	-	-	○	○	-	×	-	-	-
Dibromobenzene	<Saturated acid	×	-	-	×	-	-	○	-	-	○	-	-	○	-	-	✓	-	-	-
Dibutyl ether	Technically pure	×	-	-	×	-	-	○	-	-	○	-	-	×	-	-	✓	-	-	-
Dibutyl phthalate	Technically pure	×	-	-	×	-	-	✓	○	○	✓	○	-	○	-	-	○	-	-	-
Dichloroacetic acid	50% Aqueous	✓	✓	○	×	-	-	✓	✓	○	✓	○	-	✓	✓	✓	○	×	-	-
Dichloroacetic acid	Technically pure	✓	✓	○	×	-	-	✓	✓	○	✓	○	-	✓	✓	✓	○	-	-	-
Dichloroacetic acid methyl ester	Technically pure	×	-	-	×	-	-	✓	✓	✓	✓	✓	-	✓	✓	○	×	-	-	-
Dichlorobenzene	Technically pure	×	-	-	×	-	-	○	-	-	○	-	-	○	-	-	✓	-	-	-
Dichloroethylene	Technically pure	×	-	-	×	-	-	×	-	-	×	-	-	×	-	-	○	-	-	-
Diesel oil		✓	✓	-	×	-	-	✓	-	-	○	-	-	×	-	-	✓	-	-	-

KEY: – NO DATA × NOT RECOMMENDED ○ CONDITIONALLY RESISTANT ✓ RESISTANT

The information in these tables has been supplied by other reputable sources and is to be used ONLY as a guide in selecting equipment for appropriate chemical compatibility. Before permanent installation, test the equipment with the chemicals and under the specific conditions of your application. Ratings of chemical behaviour listed in this chart apply to a 48-hr exposure period, we have no knowledge of possible effects beyond this period. We do not warrant (neither express or implied) that the information in this chart is accurate or complete or that any material is suitable for any purpose.

Chemical resistance – table 5.06

Terrain Q is made from PPR, please follow the column labeled Polypropylene.

CHEMICAL	CONCENTRATION	MATERIAL°C																			
		PVCu			ABS			PE			POLYPROPYLENE			EPDM			FPM				
		20	40	60	20	40	60	20	40	60	20	60	100	20	40	60	20	60	100	120	
Diethyl ether		x	-	-	x	-	-	x	-	-	x	-	-	x	-	-	x	-	-	-	-
Diethylamine	Technically pure	-	-	-	x	-	-	✓	-	-	✓	-	-	○	-	-	x	-	-	-	-
Dimethyl formamide	Technically pure	x	-	-	x	-	-	✓	✓	○	✓	✓	-	○	-	-	x	-	-	-	-
Dimethylamine	Technically pure	x	-	-	x	-	-	✓	-	-	x	-	-	○	-	-	x	-	-	-	-
Dioxane	Technically pure	x	-	-	x	-	-	✓	✓	✓	○	○	-	○	-	-	x	-	-	-	-
Ethanolamine	Technically pure	x	-	-	x	-	-	✓	-	-	✓	-	-	✓	-	-	○	-	-	-	-
Ethyl alcohol (Ethnause)	Technically pure 96%	✓	✓	○	x	-	-	✓	✓	✓	✓	✓	-	✓	✓	✓	✓	○	-	-	-
Ethyl benzene	Technically pure	x	-	-	x	-	-	○	-	-	○	-	-	x	-	-	✓	-	-	-	-
Ethyl chloride (G)	Technically pure	x	-	-	x	-	-	○	-	-	○	-	-	x	-	-	○	-	-	-	-
Ethyl ether	Technically pure	x	-	-	x	-	-	✓	-	-	○	-	-	x	-	-	x	-	-	-	-
Ethylene diamine	Technically pure	○	-	-	x	-	-	✓	✓	✓	✓	✓	-	✓	-	-	○	x	-	-	-
Ethylene glycol	<50%	✓	✓	✓	○	○	-	✓	✓	✓	✓	✓	-	✓	✓	✓	✓	✓	-	-	-
Ethylene glycol	Technically pure	✓	✓	✓	x	-	-	✓	✓	✓	✓	✓	-	✓	✓	✓	✓	✓	-	-	-
Ethylenediamine -tetraacetic acid (EDTA)		-	-	-	-	-	-	✓	-	-	✓	-	-	✓	-	-	-	-	-	-	-
Fluorine	Technically pure	x	-	-	x	-	-	x	-	-	x	-	-	x	-	-	x	-	-	-	-
Fluorosilic acid	32% Aqueous	✓	✓	✓	-	-	-	✓	✓	✓	✓	✓	-	✓	-	-	○	-	-	-	-
Formaldehyde	40% Aqueous	✓	✓	-	-	-	-	✓	✓	✓	✓	-	-	✓	✓	✓	✓	✓	-	-	-
Formamide	Technically pure	x	-	-	x	-	-	✓	✓	✓	✓	✓	-	✓	-	-	○	-	-	-	-
Formic acid	≥25%	✓	✓	✓	-	-	-	✓	✓	✓	✓	✓	-	✓	✓	✓	-	-	-	-	-
Formic acid	Up to 50% aqueous	✓	✓	○	○	-	-	✓	✓	✓	✓	○	-	✓	✓	○	✓	○	-	-	-
Formic acid	Technically pure	✓	○	x	x	-	-	✓	✓	✓	✓	x	-	✓	✓	○	✓	-	-	-	-
Frigen 12 (freon 12)	Technically pure	✓	-	-	x	-	-	x	-	-	x	-	-	○	-	-	○	-	-	-	-
Fuel oil		✓	✓	-	x	-	-	✓	-	-	○	-	-	x	-	-	✓	-	-	-	-
Furfuryl alcohol	Technically pure	x	-	-	x	-	-	✓	✓	✓	✓	○	-	○	-	-	x	-	-	-	-
Gelatin	Aqueous, all	✓	✓	-	✓	✓	✓	✓	✓	✓	✓	✓	-	✓	✓	-	✓	-	-	-	-
Glucose	Aqueous, all	✓	✓	○	-	-	-	✓	✓	✓	✓	✓	-	✓	✓	✓	✓	✓	✓	-	-
Glycerol	Technically pure	✓	✓	✓	-	-	-	✓	✓	✓	✓	✓	-	✓	○	○	✓	○	-	-	-
Glycin	10% Aqueous	✓	✓	-	✓	✓	-	✓	✓	-	✓	-	-	-	-	-	✓	-	-	-	-
Glycolic acid	37% Aqueous	✓	-	-	-	-	-	✓	✓	✓	✓	-	-	-	-	-	✓	-	-	-	-
Heptane	Technically pure	✓	✓	-	x	-	-	✓	✓	-	○	-	-	x	-	-	✓	-	-	-	-

KEY: – NO DATA x NOT RECOMMENDED ○ CONDITIONALLY RESISTANT ✓ RESISTANT

The information in these tables has been supplied by other reputable sources and is to be used ONLY as a guide in selecting equipment for appropriate chemical compatibility. Before permanent installation, test the equipment with the chemicals and under the specific conditions of your application. Ratings of chemical behaviour listed in this chart apply to a 48-hr exposure period, we have no knowledge of possible effects beyond this period. We do not warrant (neither express or implied) that the information in this chart is accurate or complete or that any material is suitable for any purpose.

Chemical resistance – table 5.07

Terrain Q is made from PPR, please follow the column labeled Polypropylene.

CHEMICAL	CONCENTRATION	MATERIAL°C																			
		PVCu			ABS			PE			POLYPROPYLENE			EPDM			FPM				
		20	40	60	20	40	60	20	40	60	20	60	100	20	40	60	20	60	100	120	
Hexane	Technically pure	✓	✓	-	x	-	-	✓	✓	-	○	-	-	x	-	-	✓	-	-	-	-
Hydrazine hydrate	Aqueous	✓	-	-	x	-	-	✓	✓	✓	✓	✓	-	✓	-	-	○	-	-	-	-
Hydrochloric acid	Up to 30% aqueous	✓	✓	○	-	-	-	✓	✓	✓	✓	○	-	✓	✓	○	✓	○	-	-	-
Hydrochloric acid	38% Aqueous	✓	✓	○	x	-	-	✓	✓	-	○	-	-	✓	○	-	✓	-	-	-	-
Hydrocyanic acid	Technically pure	✓	✓	○	x	-	-	✓	✓	✓	✓	✓	-	✓	○	-	✓	-	-	-	-
Hydrofluoric acid	40%	✓	○	○	x	-	-	✓	✓	○	✓	✓	-	x	-	-	✓	○	-	-	-
Hydrogen	Technically pure	✓	✓	✓	✓	✓	✓	✓	✓	✓	✓	✓	x	✓	✓	-	✓	✓	✓	-	-
Hydrogen chloride	Technically pure gaseous	✓	✓	○	x	-	-	✓	✓	✓	✓	✓	-	✓	✓	✓	✓	✓	-	-	-
Hydrogen peroxide	30% Aqueous	✓	-	-	x	-	-	✓	-	-	✓	-	-	○	-	-	✓	-	-	-	-
Hydrogen peroxide	90% Aqueous	✓	-	-	x	-	-	○	-	-	-	-	-	x	-	-	○	-	-	-	-
Hydrogen sulphide	Saturated aqueous	✓	✓	○	-	-	-	✓	✓	✓	✓	✓	-	✓	x	-	✓	✓	-	-	-
Hydrogen sulphide	Technically pure	✓	✓	✓	-	-	-	✓	✓	○	✓	✓	-	✓	x	-	✓	○	-	-	-
Hydrquinone	30%	✓	✓	-	-	-	-	✓	✓	✓	✓	✓	-	✓	-	-	-	-	-	-	-
Iodine-potassium iodide solution (Lugol's solution)		✓	-	-	x	-	-	✓	-	-	✓	-	-	✓	-	-	✓	-	-	-	-
Iron salts, aqueous inorganic	≥Saturated acid	✓	✓	✓	✓	-	-	✓	✓	✓	✓	✓	-	✓	✓	✓	✓	✓	✓	-	-
Isocetane	Technically pure	✓	-	-	x	-	-	✓	-	-	✓	-	-	-	-	-	✓	-	-	-	-
Isopropyl alcohol (ESC)	Technically pure	✓	✓	○	-	-	-	✓	✓	○	✓	○	-	✓	✓	-	✓	-	-	-	-
Isopropyl ether	Technically pure	x	-	-	x	-	-	○	-	-	○	-	-	○	-	-	x	-	-	-	-
Lactic acid	10% Aqueous	✓	○	x	✓	○	x	✓	✓	✓	✓	✓	-	✓	✓	○	✓	○	-	-	-
Lead acetate	Aqueous saturated	✓	✓	✓	✓	✓	✓	✓	✓	✓	✓	✓	-	✓	✓	✓	✓	✓	-	-	-
Lead salts, aqueous, inorganic	≥Saturated acid	✓	✓	✓	-	-	-	✓	✓	✓	✓	✓	-	✓	✓	✓	✓	✓	-	-	-
Linseed oil	Technically pure	✓	✓	○	-	-	-	✓	✓	✓	✓	✓	-	✓	✓	✓	✓	✓	-	-	-
Lithium salts, aqueous, inorganic	≥Saturated acid	✓	✓	✓	-	-	-	✓	✓	✓	✓	✓	-	✓	✓	✓	✓	✓	-	-	-
Magnesium salts, aqueous inorganic	≥Saturated acid	✓	✓	○	-	-	-	✓	✓	✓	✓	✓	-	✓	✓	✓	✓	✓	-	-	-
Maleic acid	Cold saturated aqueous	✓	✓	○	-	-	-	✓	✓	✓	✓	✓	-	✓	✓	✓	✓	✓	-	-	-
Mercury	Pure	✓	✓	✓	✓	-	-	✓	✓	✓	✓	✓	-	✓	✓	✓	✓	✓	-	-	-
Mercury salts	≥Saturated acid	✓	✓	○	-	-	-	✓	✓	✓	✓	✓	-	✓	✓	✓	✓	✓	-	-	-
Methane (natural gas)	Technically pure	✓	-	-	✓	-	-	✓	-	-	✓	-	-	✓	-	-	✓	-	-	-	-
Methanol	All	✓	✓	○	x	-	-	✓	✓	✓	✓	✓	-	✓	✓	✓	○	○	-	-	-
Methyl acetate	Technically pure	x	-	-	x	-	-	✓	-	-	✓	-	-	✓	-	-	x	-	-	-	-

KEY: – NO DATA x NOT RECOMMENDED ○ CONDITIONALLY RESISTANT ✓ RESISTANT

The information in these tables has been supplied by other reputable sources and is to be used ONLY as a guide in selecting equipment for appropriate chemical compatibility. Before permanent installation, test the equipment with the chemicals and under the specific conditions of your application. Ratings of chemical behaviour listed in this chart apply to a 48-hr exposure period, we have no knowledge of possible effects beyond this period. We do not warrant (neither express or implied) that the information in this chart is accurate or complete or that any material is suitable for any purpose.

Chemical resistance – table 5.08

Terrain Q is made from PPR, please follow the column labeled Polypropylene.

CHEMICAL	CONCENTRATION	MATERIAL°C																			
		PVCu			ABS			PE			POLYPROPYLENE			EPDM			FPM				
		20	40	60	20	40	60	20	40	60	20	60	100	20	40	60	20	60	100	120	
Methyl amine	32% Aqueous	○	-	-	×	-	-	✓	-	-	✓	-	-	✓	-	-	×	-	-	-	-
Methyl bromide	Technically pure	×	-	-	×	-	-	○	-	-	×	-	-	×	-	-	○	-	-	-	-
Methyl ethyl ketone	Technically pure	×	-	-	×	-	-	✓	-	-	✓	-	-	✓	-	-	×	-	-	-	-
Methyl isobutyl ketone		×	-	-	×	-	-	✓	-	-	✓	-	-	✓	-	-	×	-	-	-	-
Methyl methacrylate		×	-	-	×	-	-	✓	-	-	✓	-	-	✓	-	-	×	-	-	-	-
Methyl phenyl(acetophenon)		×	-	-	×	-	-	✓	-	-	✓	-	-	✓	-	-	×	-	-	-	-
Milk		✓	✓	✓	✓	✓	✓	✓	✓	✓	✓	✓	✓	-	-	-	✓	-	-	-	-
Mineral water		✓	✓	✓	✓	✓	✓	✓	✓	✓	✓	✓	✓	✓	✓	✓	✓	✓	✓	✓	✓
Mixed acids - nitric 15% - hydrofluoric 15% - sulphuric 18%	3 parts 1 part 2 parts	✓	-	-	×	-	-	○	-	-	×	-	-	×	-	-	✓	-	-	-	-
Mixed acids - sulphuric - nitric - water	10% 20% 70%	✓	✓	✓	×	-	-	✓	-	-	×	-	-	×	-	-	✓	✓	-	-	-
Mixed acids - sulphuric - nitric - water	50% 33% 17%	✓	○	-	×	-	-	×	-	-	×	-	-	×	-	-	✓	-	-	-	-
Mixed acids - sulphuric - nitric - water	50% 31% 19%	✓	-	-	×	-	-	×	-	-	×	-	-	×	-	-	✓	-	-	-	-
Mixed acids - sulphuric - phosphoric - water	30% 60% 10%	✓	✓	-	×	-	-	✓	✓	✓	✓	✓	-	✓	✓	✓	✓	✓	-	-	-
N, N-Dimethylaniline	Technically pure	×	-	-	×	-	-	✓	-	-	✓	-	-	✓	-	-	-	-	-	-	-
N, methylpyrrolidon		×	-	-	×	-	-	✓	-	-	✓	-	-	✓	-	-	○	-	-	-	-
Naphthalene	Technically pure	×	-	-	-	-	-	✓	-	-	✓	-	-	×	-	-	✓	-	-	-	-
Nickel salts, aqueous in organic	≥Saturated acid	✓	✓	○	-	-	-	✓	✓	✓	✓	✓	-	✓	✓	✓	✓	✓	-	-	-
Nitrating acid - sulphuric acid - nitric acid - water	65% 20% 15%	✓	○	-	-	-	-	×	-	-	×	-	-	×	-	-	✓	-	-	-	-
Nitric acid	6.3% Aqueous	✓	✓	✓	-	-	-	✓	✓	✓	✓	○	-	✓	○	-	✓	✓	-	-	-
Nitric acid	≥25%	✓	✓	✓	×	-	-	✓	✓	○	✓	-	-	✓	-	-	✓	-	-	-	-
Nitric acid	65% Aqueous	○	○	×	×	-	-	○	×	-	×	-	-	×	-	-	✓	×	-	-	-
Nitric acid	85%	×	-	-	×	-	-	×	-	-	×	-	-	×	-	-	✓	-	-	-	-
Nitric acid	100%	×	-	-	×	-	-	×	-	-	×	-	-	×	-	-	×	-	-	-	-

KEY: – NO DATA × NOT RECOMMENDED ○ CONDITIONALLY RESISTANT ✓ RESISTANT

The information in these tables has been supplied by other reputable sources and is to be used ONLY as a guide in selecting equipment for appropriate chemical compatibility. Before permanent installation, test the equipment with the chemicals and under the specific conditions of your application. Ratings of chemical behaviour listed in this chart apply to a 48-hr exposure period, we have no knowledge of possible effects beyond this period. We do not warrant (neither express or implied) that the information in this chart is accurate or complete or that any material is suitable for any purpose.

Chemical resistance – table 5.09

Terrain Q is made from PPR, please follow the column labeled Polypropylene.

CHEMICAL	CONCENTRATION	MATERIAL°C																			
		PVCu			ABS			PE			POLYPROPYLENE			EPDM			FPM				
		20	40	60	20	40	60	20	40	60	20	60	100	20	40	60	20	60	100	120	
Nitrobenzene	Technically pure	×	-	-	×	-	-	✓	-	-	✓	-	-	○	-	-	✓	-	-	-	-
Nitrotoluene (o-, m-, p-)	Technically pure	×	-	-	×	-	-	✓	○	-	○	-	-	×	-	-	○	-	-	-	-
Nitrous acid		✓	✓	-	×	-	-	✓	-	-	×	-	-	✓	-	-	✓	-	-	-	-
Nitrous gases (nitric oxide)	Diluted, moist, anhydrous	✓	-	-	×	-	-	○	-	-	○	-	-	○	-	-	✓	-	-	-	-
Oleic	Technically pure	✓	✓	✓	×	-	-	✓	✓	○	✓	○	-	×	-	-	✓	×	-	-	-
Oleum	10% SO3	×	-	-	×	-	-	×	-	-	×	-	-	×	-	-	×	-	-	-	-
Olive oil		✓	✓	✓	×	-	-	✓	✓	○	✓	✓	-	×	-	-	✓	✓	-	-	-
Oxygen	Technically pure	✓	✓	✓	-	-	-	✓	✓	○	✓	○	-	✓	✓	✓	✓	✓	✓	✓	✓
Ozone	Up to 2%, in air	✓	-	-	×	-	-	○	-	-	○	-	-	○	-	-	✓	-	-	-	-
Ozone	Cold saturated, aqueous	✓	-	-	×	-	-	○	-	-	○	-	-	×	-	-	✓	-	-	-	-
Palm oil, palm nut oil		✓	-	-	-	-	-	✓	-	-	✓	-	-	×	-	-	✓	-	-	-	-
Paraffin emulsions	Usual commercial, aqueous	✓	-	-	-	-	-	✓	-	-	✓	-	-	×	-	-	✓	-	-	-	-
Paraffin oil		✓	-	-	○	-	-	✓	-	-	✓	-	-	×	-	-	✓	-	-	-	-
Perchloric acid	10% Aqueous	✓	-	-	-	-	-	✓	-	-	✓	-	-	✓	-	-	✓	-	-	-	-
Perchloric acid	70% Aqueous	✓	-	-	×	-	-	-	-	-	×	-	-	×	-	-	✓	-	-	-	-
Perchloroethylene (tetrachlorethylene)	Technically pure	×	-	-	-	-	-	○	-	-	○	-	-	×	-	-	✓	✓	-	-	-
Phenol	Up to 10% aqueous	✓	○	-	×	-	-	✓	✓	○	✓	✓	-	✓	✓	○	✓	✓	-	-	-
Phenol	Up to 90% aqueous	○	-	-	×	-	-	✓	✓	○	✓	✓	-	×	-	-	✓	×	-	-	-
Phosgene	Gaseous technically pure	✓	○	○	×	-	-	○	-	-	○	-	-	✓	-	-	✓	○	-	-	-
Phosgene	Liquid, technically pure	×	-	-	×	-	-	×	-	-	×	-	-	×	-	-	✓	-	-	-	-
Phosphoric acid	85% Aqueous	✓	✓	✓	-	-	-	✓	✓	✓	✓	✓	-	✓	✓	○	✓	✓	○	-	-
Phosphoric acid	Up to 95%	✓	✓	-	×	-	-	✓	✓	-	✓	✓	-	○	-	-	✓	○	-	-	-
Phosphorous chlorides - trichloride - pentachloride - oxichloride	Technically pure	×	-	-	×	-	-	×	-	-	×	-	-	-	-	-	×	-	-	-	-
Photographic developer	Usual commercial	✓	✓	○	✓	✓	○	✓	✓	○	✓	-	-	✓	✓	-	✓	-	-	-	-
Photographic emulsions		✓	✓	-	✓	✓	-	✓	✓	-	✓	-	-	✓	✓	-	✓	-	-	-	-
Photographic fixer	Usual commercial	✓	✓	○	✓	✓	○	✓	✓	-	✓	-	-	✓	✓	-	✓	-	-	-	-
Phthalic acid	Saturated, aqueous	✓	○	×	×	-	-	✓	✓	✓	✓	✓	-	✓	○	-	×	-	-	-	-
Potassium hydroxide	50%	✓	✓	✓	-	-	-	✓	✓	✓	✓	○	-	✓	✓	✓	×	-	-	-	-

KEY: – NO DATA × NOT RECOMMENDED ○ CONDITIONALLY RESISTANT ✓ RESISTANT

The information in these tables has been supplied by other reputable sources and is to be used ONLY as a guide in selecting equipment for appropriate chemical compatibility. Before permanent installation, test the equipment with the chemicals and under the specific conditions of your application. Ratings of chemical behaviour listed in this chart apply to a 48-hr exposure period, we have no knowledge of possible effects beyond this period. We do not warrant (neither express or implied) that the information in this chart is accurate or complete or that any material is suitable for any purpose.

Chemical resistance – table 5.10

Terrain Q is made from PPR, please follow the column labeled Polypropylene.

CHEMICAL	CONCENTRATION	MATERIAL°C																			
		PVCu			ABS			PE			POLYPROPYLENE			EPDM			FPM				
		20	40	60	20	40	60	20	40	60	20	60	100	20	40	60	20	60	100	120	
Potassium aluminium salts, (alum), aqueous, inorganic	≤Saturated acid	✓	✓	✓	-	-	-	✓	✓	✓	✓	✓	-	✓	✓	✓	-	-	-	-	-
Potassium persulphate (potassium peroxodisulfate)	All, aqueous	✓	✓	○	-	-	-	✓	✓	✓	✓	✓	-	✓	✓	-	✓	✓	-	-	-
Potassium hypochlorite		✓	○	-	-	-	-	○	-	-	○	-	-	✓	-	-	○	-	-	-	-
Propane	Technically pure, gaseous	✓	✓	-	-	-	-	○	-	-	✓	-	-	-	-	-	✓	-	-	-	-
Propane	Technically pure, liquid	✓	✓	-	-	-	-	✓	-	-	✓	-	-	-	-	-	✓	-	-	-	-
Propanol, n- and iso-	Technically pure	✓	○	○	-	-	-	✓	✓	○	✓	○	-	✓	✓	○	✓	-	-	-	-
Propionic acid	50% Aqueous	✓	✓	○	×	-	-	✓	✓	✓	✓	✓	-	✓	✓	-	○	-	-	-	-
Propionic acid	Technically pure	✓	○	-	×	-	-	✓	○	○	✓	○	-	✓	○	-	✓	✓	-	-	-
Propylene glycol	<50%	✓	✓	✓	-	-	-	✓	✓	✓	✓	✓	-	✓	✓	-	✓	○	-	-	-
Propylene glycol	Technically pure	✓	✓	✓	✓	-	-	✓	✓	✓	✓	✓	-	✓	✓	✓	✓	✓	-	-	-
Pyridine	Technically pure	×	-	-	×	-	-	✓	○	○	○	○	-	○	-	-	×	-	-	-	-
Salicylic acid	Saturated	✓	✓	✓	-	-	-	✓	✓	✓	✓	✓	-	✓	✓	✓	✓	-	-	-	-
Sea water		✓	✓	○	✓	✓	✓	✓	✓	✓	✓	✓	✓	✓	✓	✓	✓	✓	✓	-	-
Silicic acid		✓	✓	✓	-	-	-	✓	✓	✓	✓	✓	-	✓	✓	✓	✓	-	-	-	-
Silicone oil		✓	○	×	✓	-	-	✓	✓	✓	✓	✓	-	✓	✓	✓	✓	✓	-	-	-
Silver salts, aqueous, inorganic	≤Saturated acid	✓	✓	✓	✓	-	-	✓	✓	✓	✓	✓	-	✓	✓	✓	✓	✓	-	-	-
Sodium chlorite	Diluted, aqueous	✓	-	-	-	-	-	○	-	-	○	-	-	○	-	-	✓	-	-	-	-
Sodium hypochlorite	12.5% Active chlorine, aqueous	✓	✓	-	×	-	-	○	○	-	○	-	-	✓	✓	-	○	-	-	-	-
Sodium persulphate	Cold saturated, aqueous	✓	✓	○	-	-	-	✓	✓	✓	✓	✓	-	✓	✓	-	✓	✓	-	-	-
Sodium salts, aqueous, inorganic	≤Saturated acid	✓	✓	✓	-	-	-	✓	✓	✓	✓	✓	-	✓	✓	✓	✓	✓	-	-	-
Stannous chloride	Cold saturated, aqueous	✓	○	○	✓	✓	-	✓	✓	✓	✓	✓	-	✓	○	×	✓	✓	-	-	-
Starch solution	Aqueous all	✓	✓	✓	✓	✓	-	✓	✓	✓	✓	✓	-	✓	✓	✓	✓	✓	-	-	-
Styrene		×	-	-	×	-	-	-	-	-	-	-	-	-	-	-	✓	-	-	-	-
Succinic acid	Aqueous ,all	✓	✓	✓	✓	-	-	✓	✓	✓	✓	✓	-	✓	✓	✓	✓	✓	-	-	-
Sulfuryl chloride	Technically pure	×	-	-	×	-	-	×	-	-	×	-	-	-	-	-	✓	-	-	-	-
Sulphur dioxide	Technically pure, liquid	×	-	-	×	-	-	×	-	-	×	-	-	×	-	-	○	-	-	-	-
Sulphur dioxide	All, moist	✓	✓	○	×	-	-	✓	✓	✓	✓	✓	-	✓	○	×	✓	×	-	-	-
Sulphuric acid	Saturated aqueous	✓	✓	○	-	-	-	✓	✓	✓	✓	✓	-	✓	×	-	✓	○	-	-	-
Sulphuric acid	Up to 80% aqueous	✓	✓	✓	×	-	-	✓	✓	○	✓	○	-	○	○	×	✓	○	-	-	-
Sulphuric acid	Up to 96% aqueous	✓	✓	○	×	-	-	×	-	-	×	-	-	×	-	-	✓	✓	-	-	-

KEY: – NO DATA × NOT RECOMMENDED ○ CONDITIONALLY RESISTANT ✓ RESISTANT

The information in these tables has been supplied by other reputable sources and is to be used ONLY as a guide in selecting equipment for appropriate chemical compatibility. Before permanent installation, test the equipment with the chemicals and under the specific conditions of your application. Ratings of chemical behaviour listed in this chart apply to a 48-hr exposure period, we have no knowledge of possible effects beyond this period. We do not warrant (neither express or implied) that the information in this chart is accurate or complete or that any material is suitable for any purpose.

Chemical resistance – table 5.11

Terrain Q is made from PPR, please follow the column labeled Polypropylene.

CHEMICAL	CONCENTRATION	MATERIAL°C																						
		PVCu			ABS			PE			POLYPROPYLENE			EPDM			FPM							
		20	40	60	20	40	60	20	40	60	20	60	100	20	40	60	20	60	100	120				
Sulphuric acid	98%	✓	○	-	×	-	-	×	-	-	×	-	-	×	-	-	×	-	-	○	-	-	-	
Tannic acid	Aqueous all	✓	-	-	-	-	-	✓	✓	✓	✓	✓	-	-	-	-	✓	-	-	-	✓	-	-	-
Tetrachlorethylene (perchloroethylene)		×	-	-	×	-	-	×	-	-	×	-	-	×	-	-	×	-	-	✓	-	-	-	
Tetrachloroethane	Technically pure	×	-	-	×	-	-	○	-	-	○	-	-	×	-	-	○	-	-	○	-	-	-	
Tetraethylene lead	Technically pure	✓	-	-	×	-	-	✓	-	-	✓	-	-	○	-	-	○	-	-	✓	-	-	-	
Tetrahydrofuran	Technically pure	×	-	-	×	-	-	○	-	-	○	-	-	○	-	-	○	-	-	×	-	-	-	
Tin salts, aqueous, inorganic	≤Saturated acid	✓	✓	✓	-	-	-	✓	✓	✓	✓	✓	-	✓	✓	✓	✓	✓	✓	✓	✓	-	-	
Toluene	Technically pure	×	-	-	×	-	-	○	-	-	○	-	-	×	-	-	✓	-	-	-	-	-	-	
Trichloromethane	100%	-	-	-	-	-	-	-	-	-	-	-	-	-	-	-	-	-	-	✓	-	-	-	
Trichloroacetic acid	50% Aqueous	✓	○	-	×	-	-	✓	✓	✓	✓	✓	-	✓	○	-	○	-	-	×	-	-	-	
Trichloroacetic acid	Technically pure	○	-	-	×	-	-	✓	○	×	✓	○	-	○	-	-	○	-	-	×	-	-	-	
Trichloroethane	Technically pure	×	-	-	×	-	-	○	-	-	○	-	-	×	-	-	✓	-	-	✓	-	-	-	
Trichloroethylene	Technically pure	×	-	-	×	-	-	×	-	-	○	-	-	×	-	-	✓	-	-	✓	-	-	-	
Triethylamine	Technically pure	×	-	-	×	-	-	✓	-	-	✓	-	-	×	-	-	×	-	-	×	-	-	-	
Trifluoroacetic acid	Up to 50%	×	-	-	×	-	-	✓	-	-	✓	-	-	○	-	-	○	-	-	×	-	-	-	
Turpentine oil	Technically pure	✓	○	-	×	-	-	○	○	-	×	-	-	×	-	-	×	-	-	✓	✓	-	-	
Urea	Up to 30% aqueous	✓	✓	○	✓	✓	-	✓	✓	✓	✓	✓	-	✓	✓	✓	✓	✓	✓	✓	✓	-	-	
Urine		✓	✓	○	-	-	-	✓	✓	✓	✓	✓	-	✓	✓	✓	✓	✓	✓	✓	✓	-	-	
Vinyl acetate	Technically pure	×	-	-	×	-	-	✓	✓	-	✓	○	-	✓	-	-	×	-	-	×	-	-	-	
Vinyl chloride	Technically pure	×	-	-	×	-	-	×	-	-	×	-	-	×	-	-	×	-	-	✓	-	-	-	
Waste gases, containing alkaline		✓	✓	✓	-	-	-	✓	✓	✓	✓	✓	-	✓	✓	✓	✓	✓	✓	✓	✓	×	-	
Waste gases, containing hydrochloric acid	All	✓	✓	✓	-	-	-	✓	✓	✓	✓	✓	-	✓	✓	✓	✓	✓	✓	✓	✓	✓	-	
Waste gases, containing hydrogen fluoride	Traces	✓	✓	✓	-	-	-	✓	✓	✓	✓	✓	-	○	○	○	✓	✓	-	○	○	○	-	
Waste gases, containing nitrous gases	Traces	✓	✓	✓	-	-	-	✓	○	○	○	○	-	✓	○	○	✓	○	○	✓	✓	○	-	
Waste gases, containing sulphur dioxide	Traces	○	✓	-	-	-	-	✓	✓	-	✓	-	-	✓	✓	✓	✓	✓	✓	✓	✓	✓	-	
Water, drinking, chlorinated	≤0.1ppm Chlorine	✓	✓	✓	✓	✓	✓	✓	✓	✓	✓	✓	-	✓	✓	✓	✓	✓	○	✓	✓	✓	-	
Water - distilled - deionised		✓	✓	✓	✓	✓	✓	✓	✓	✓	✓	✓	-	✓	✓	✓	✓	✓	○	✓	✓	✓	✓	
Xylene	Technically pure	×	-	-	×	-	-	×	-	-	×	-	-	×	-	-	×	-	-	✓	×	-	-	
Zinc salts, aqueous, inorganic	≤Saturated acid	✓	✓	✓	✓	-	-	✓	✓	✓	✓	✓	-	✓	✓	✓	✓	✓	✓	✓	✓	-	-	

KEY: – NO DATA × NOT RECOMMENDED ○ CONDITIONALLY RESISTANT ✓ RESISTANT

The information in these tables has been supplied by other reputable sources and is to be used ONLY as a guide in selecting equipment for appropriate chemical compatibility. Before permanent installation, test the equipment with the chemicals and under the specific conditions of your application. Ratings of chemical behaviour listed in this chart apply to a 48-hr exposure period, we have no knowledge of possible effects beyond this period. We do not warrant (neither express or implied) that the information in this chart is accurate or complete or that any material is suitable for any purpose.

6. Polypipe Advantage

Polypipe Advantage Service is more than fabrication, it is a service that supports and offers design and technical support on your next project.

Find out more about how Polypipe Advantage can help you get the results you want.

Visit: polypipe.com/polypipeadvantage
Call us on 01622 795200



ASSESSMENT AND ESTIMATION

Every good project begins with a thorough plan. The Polypipe Advantage team is on hand from the outset, to appraise your enquiry to identify any unique project requirements before creating a draft estimate.

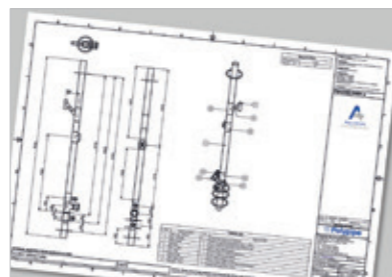

DESIGN

The Polypipe Advantage team will produce detailed CAD drawings for approval, all designs are compliant to as-drawn dimensions. This means you save vital planning time and won't have to compromise with inappropriate or over-engineered solutions.



DISPATCH AND DELIVERY

We know that time and scheduling are critical for any project, so we ensure your system is delivered how and when you need it – while keeping you updated along the way. Our team of logistics experts work with your project timelines to ensure each element of your system arrives to site as scheduled.

Storage and Handling

GOOD SITE PRACTICE

- Do not throw, drop pipes, or drag them along hard surfaces
- In case of mechanical handling, use protective slings and padded supports. Metal chains and hooks should not make contact with the pipe

ON-SITE STORAGE

- Stack pipe lengths
 - on a flat base
 - on level ground
 - or on 75mm x 75mm timber at 1m centers (fig 6.01)
- Provide side support with 75mm wide battens at 1m centres (Fig. 6.01)
- Maximum stack should not exceed 1.5m high
- Ideally, stacks should contain one diameter pipe size only. Where this is not possible, stack largest diameter pipes at base of stack. Small pipes may be nested inside larger pipes
- If stored in the open for long periods or exposed to strong sunlight, cover the stack with opaque sheeting
- Store fittings under cover. Do not remove from cartons or packaging until required

STORAGE IN HOT CLIMATES

- Ultra-violet light can affect pipes and fittings: pipe colour may change and rubber seals may be degraded
- Store accordingly:
 - store all materials in well-ventilated, shady conditions
 - do NOT expose to direct sunlight
 - keep fittings in original packaging until required for use
- Maximum stack (hot conditions): six layers high

SITE SAFETY

- The relevant regulations detailed in the Health & Safety at Work Act 1974, Construction Design and Management Regulations 2015, must be adhered to on-site
- MSDS data sheets are available on request

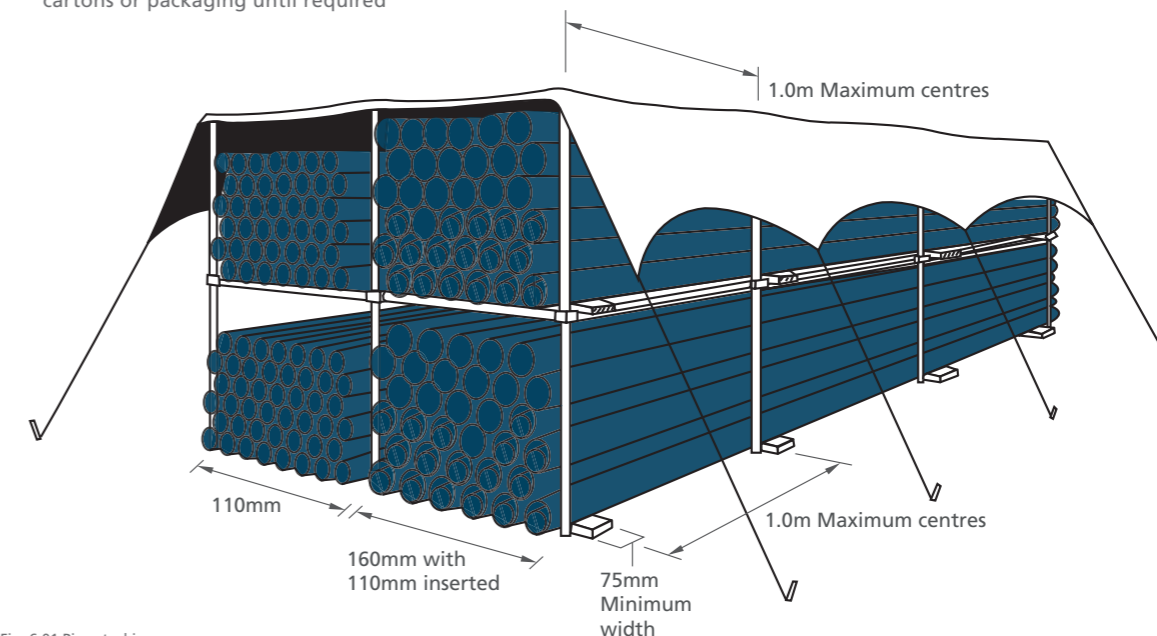

Fig. 6.01 Pipe stacking

7. Installation

Design considerations

When designing a system, the following aspects must be considered:

BUILDING REGULATION REQUIREMENTS

- All sanitary pipework and drainage installations must satisfy the relevant requirements of Part H of the approved documents to the England, Wales and Northern Ireland Building Regulations and the Building (Scotland) Regulations 2004.
- Installations in accordance with BS EN 12056:2
- Code of practice for sanitary pipework will also meet Building Regulation requirements.

VENTILATION

The discharge stack must be ventilated in order to prevent pressure building up within the system and drawing the water seals in the traps. Separate ventilation of branch pipes is required only if the length and slope of the branch exceeds the dimension stated in the regulations. Please refer to table 7.04.

In such cases, the branch pipe should be ventilated by a branch ventilating pipe or an anti-siphon trap should be fitted. The Automatic Air Admittance Valve reduces the number of stack ventilating pipes required to penetrate the roof in multi-installations, without affecting performance of the drainage system.

BRANCH CONNECTIONS

The distance between the centreline of the lowest branch connection to the discharge stack and the invert of the bend at the foot of the stack should be in accordance with the following:

- ≤3 storeys - 450mm min.
- ≤5 storeys - 750mm min.
- 5 storeys + - Ground floor connections should discharge direct to drain or into their own stack.
- 20 storeys + - Ground floor and first floor connections should discharge into their own stack.

A branch pipe should not discharge into a stack in a way which could cause crossflow into any other branch pipe.

WORKING TEMPERATURES

Terrain Q may be used to convey liquids with a maximum temperature of 80°C when subjected to continuous flow. Intermittent discharges of up to 97°C may occur providing they are of less than 2 minutes duration.

CHEMICAL DISCHARGES

Terrain Q is resistant to most commonly used acids and those that may be discharged to the public sewer system. The rubber seals, however, are less resistant and it is advised that before any chemicals are conveyed through the systems, checks are made to establish their effects on the product. Refer to BS CP 312 Part 1 Code of Practice for Plastic Pipework for further information.

ACCESS

Sufficient and suitable access must be provided to enable all pipework to be tested and maintained effectively. Access covers, plugs or caps should be installed in positions to facilitate use of testing equipment and removal of blockages.

FIRE SPREAD

In large commercial or housing developments, compartmentation may be required by the Building Regulations 2010 (Part B). In such cases, any penetrations by sanitary pipework must be suitably fire stopped. Suitable measures include the containment of pipes from floor to ceiling in a fire resistant enclosure (with appropriate fire rating).

PIPE SUPPORT

Pipes must be adequately supported when installed vertically or horizontally (to falls).

General notes

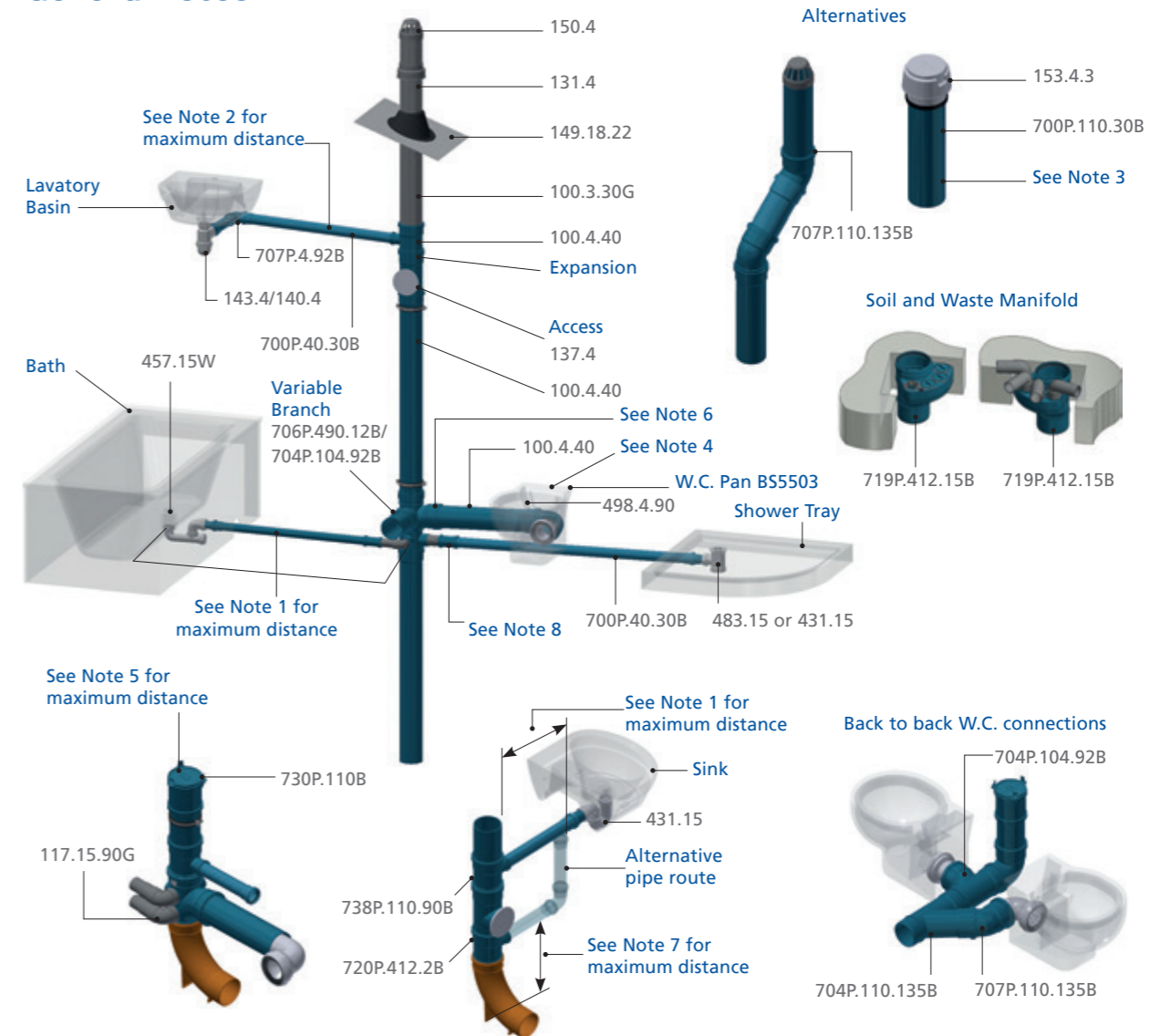

NOTE: For buried drain details see other supporting documents

- Gradients** - Gradients should be between 1 and 5 degrees with a maximum distance of 3 metres. Distances over 3 metres are prone to blockage and should therefore be provided with access.
- Venting** - Maximum distance from stack for unvented system is 1.7 metres according to angle (see diagram for details). Above 1.7 metres, venting is required, and if this is impractical then a suitable re-sealing trap should be used.
- Air Admittance Valves** - Air admittance valves may be fitted as an alternative to an open vent, however an open vent must be allowed at the head of a drain. For further details see agreement Certificate No 06/4343 - what is agreement certificate?
- Terrain Pleura** - Terrain Pleura may be fitted as an alternative ventilation system. The Pleura 50 protects the fixtures connected to the branch drain with the Pleura 100

- and the Terrain P.A.P.A.® together protecting the stack against positive and negative air pressures. An open vent must be allowed at the head of the drain.
- W.C. Connectors** - W.C. connectors shown are to horizontal outlet pans (to BSEN997).
 - Stub Stacks** - Stub stacks are used to connect one set of domestic appliances. A to be maximum of 2.0 metres and B (to crown of W.C. trap) to be maximum of 1.5 metres.
 - Connection Zones** - Although four bosses have been provided on branches and access pipes certain connections are not allowed under EN 12056.
 - Distances** - Distance must be a minimum of 450mm for single houses up to 3 storeys, or a minimum of 750mm up to 5 storeys, or one storey height for 5 storey buildings and over. Minimum radius of bend 200mm or alternative of 2 No.45 degree bends.

Thermal expansion – polypropylene

Terrain Q, a polypropylene drainage system, expands and contracts with changes in temperature, both ambient temperature and from the temperature of the waste discharge through the pipework. This guide describes the principles of thermal movement allowance and provides advice covering assembly and jointing techniques.

CALCULATING THERMAL MOVEMENT

Terrain Q has a coefficient of expansion of 0.08 (mm/m/°C), the design and installation of above ground drainage systems must be able to accommodate for this. Calculate the thermal movement on straight lengths between anchors using:

$$\Delta L = L \Delta T$$

Where:

ΔL = Expansion (mm) or contraction (-mm)

= Co-efficient of linear expansion (mm/m/°C)
Terrain Q 0.08

L = Total length of the pipe between anchor points (m)

ΔT = Temperature difference (°C)

Note: For waste discharges ΔT should always be calculated from 0°C so if the max. water temperature is 60°C, ΔT is 60°C.

The advice and guidance is based on typical situations only. For further information contact the Polypipe Advantage Technical Department. Terrain Q offers substantial durability against the flow of hot water. A waste pipe with no mechanical load will tolerate temperatures of up to 80°C and up to 97°C is permissible for a maximum of two minutes. Thermal movement MUST always be accounted for (see the following information).

Example 1 – Typical vertical stack

Typical vertical stack A 10 story foul drainage stack will collect and convey domestic waste (assumed temperature 60°C) and connect directly to drain. Each story is 3m high.

$$\Delta L = L \Delta T$$

$$\Delta T = 0.08 \times 3.0 \times 60 = 14.4\text{mm}$$

thermal movement per floor.

Example 2 – Typical suspended pipe run

A 20m high-level lateral run has been designed in an open car park area. The maximum length between fixed points should be 3m. The assumed temperature of the waste fluid is 50°C

$$\Delta L = L \Delta T$$

$$\Delta T = 0.08 \times 3.0 \times 50 = 12\text{mm}$$

thermal movement between anchor points.

Vertical push-fit system

DISTANCE BETWEEN HORIZONTAL BRACKETS

The brackets settle in such a way that the distance between them never exceed the recommended distance, as shown below in table 7.01

DISTANCE BETWEEN HORIZONTAL BRACKETS		
DIAMETER (mm)	DISTANCE BETWEEN HORIZONTAL BRACKETS (Lpg)	DISTANCE BETWEEN BRACKETS (Lpf)
40	0.50	The maximum distance between fixed points should not exceed 3m
50	0.50	
75	0.80	
110	1.10	
160	1.60	
200	1.70	

Table 7.01

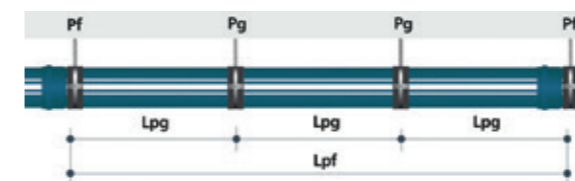

DISTANCE BETWEEN VERTICAL BRACKETS

The brackets settle in such a way that the distance between them never exceed the recommended distance, as shown below in table 7.02

DISTANCE BETWEEN VERTICAL BRACKETS		
DIAMETER (mm)	DISTANCE BETWEEN VERTICAL BRACKETS (Lpg)	DISTANCE BETWEEN BRACKETS (Lpf)
40	1.20	The maximum distance between fixed points should not exceed 3m
50	1.50	
75	2.00	
110	2.00	
160	2.00	
200	2.00	

Table 7.02

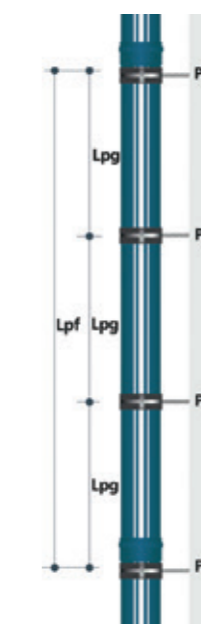
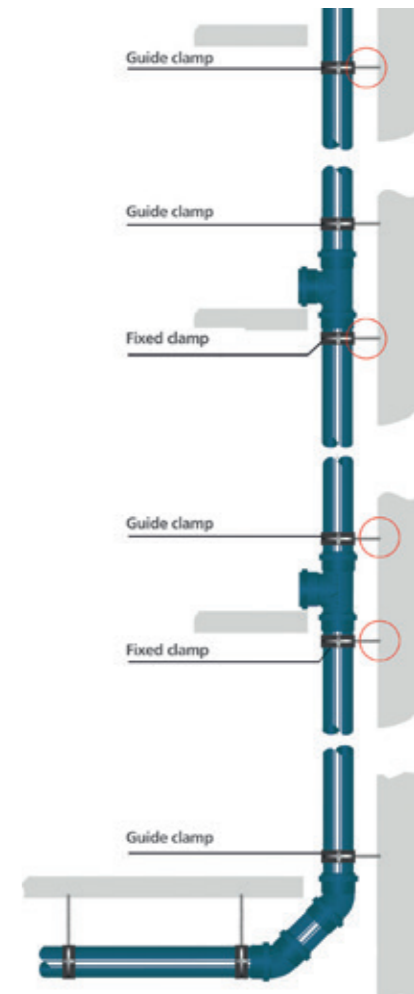

Acoustic installation guidance

Installation of all sanitary pipework should be carried out in accordance with EN 12056 Parts 1, 2 and 5 which covers all aspects of sanitary pipework design and installation.

To improve the acoustic performance of the drainage system, the installation should seek to minimise turbulence and the creation of bubbles which impact on the pipe wall.

Take care with the following:

- Optimise the flow of wastewater use smooth wall pipes.
- Avoid sudden changes in speed of wastewater i.e. rapid changes in pipe diameter.
- Avoid abrupt changes in direction to promote free flow - this can be achieved in the change from vertical to horizontal by using 2 x 45° bends, creating a long radius bend.
- Sound dampening bracket sounds allow for the control of thermal movement.
- Avoid contact between the pipe and the building structure i.e. floor / wall / ceiling by installing an insulation layer in the penetration hole before 'making good' the hole.

Following points are referenced from Building Regulations Part E.

- Pipes that penetrate the floor separating habitable rooms in different apartments should be enclosed to their full height.
- The enclosure should be constructed of a material having a mass per unit area of at least 15kg/m². Either line the enclosure or wrap the pipe with 25mm unfaced mineral fibre.
- Pipe penetrations through a separate floor should have fire protection to satisfy Building Regulation Part B – Fire Safety. Fire stopping should be flexible and prevent rigid contact between the pipe and floor.

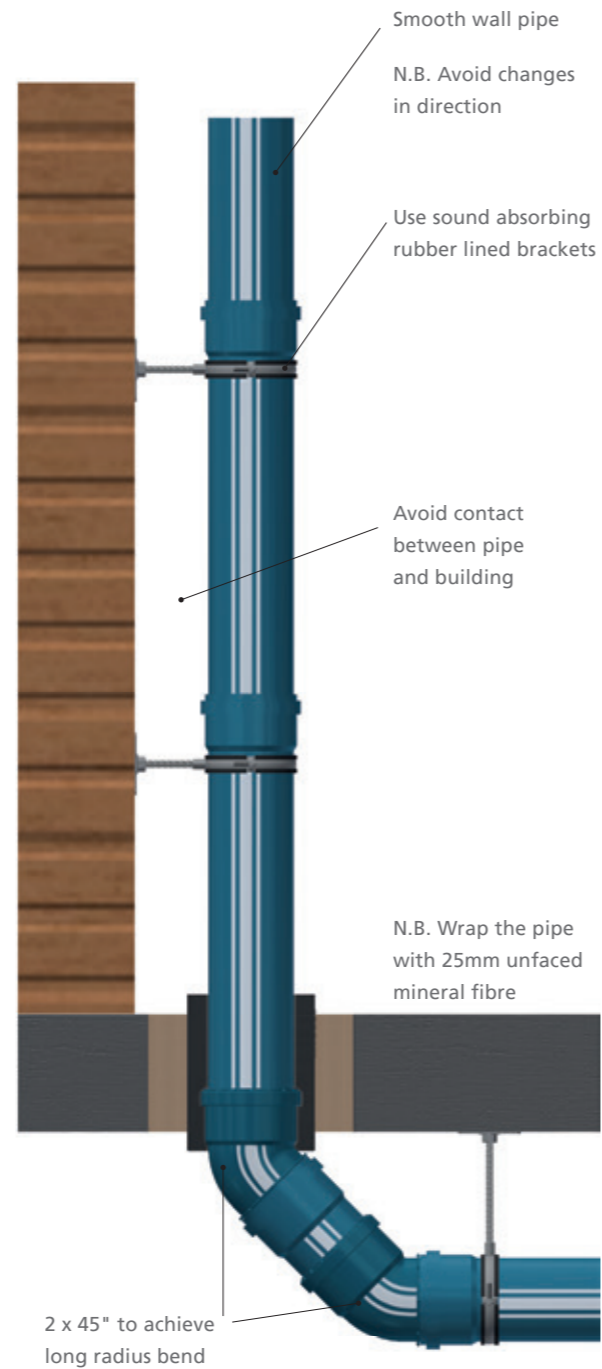

Managing sounds at changes of direction

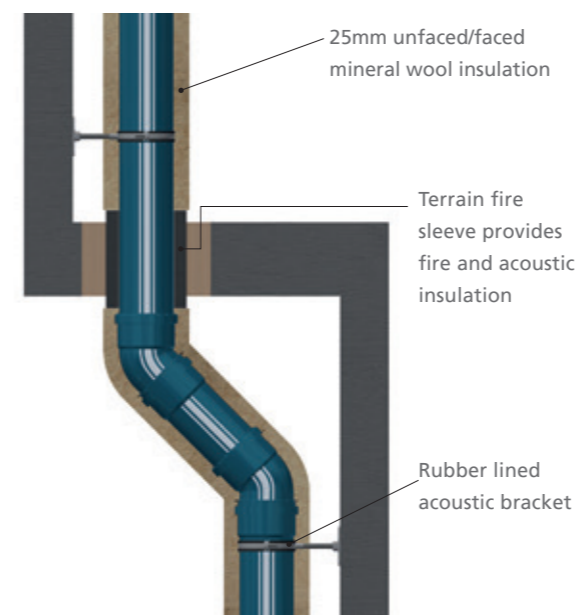
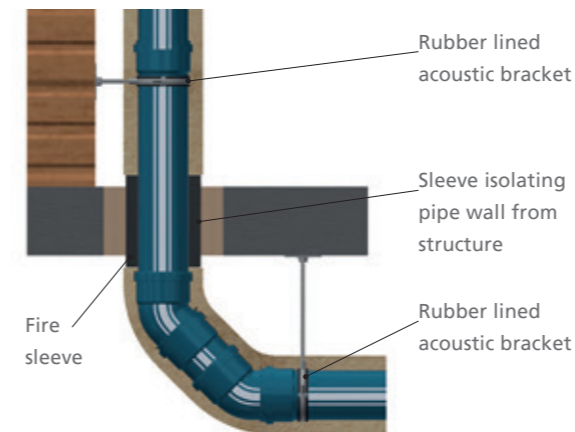

Installation A - 2 x Bends 45°

This is **THE BEST** solution because:

- It allows for the greatest control of pressure in the system.
- The noise level is the lowest of all installation solutions.
- Adding a small section of pipe achieves a long radius bend.

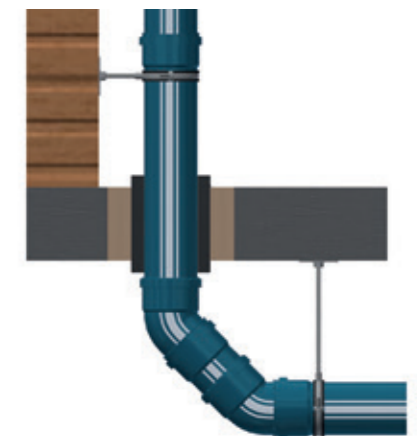

Installation B - Bend 90°

This type of installation is **NOT RECOMMENDED** because:

- It allows pressure to build up in the stack.
- There is a high risk of siphonage
- There is a significant increase in sound.

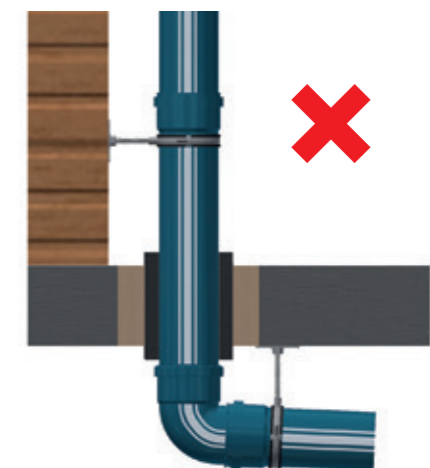

For branch pipe sizing based on System III the following sizing charts should be used.

SIZING CHART - UNVENTILATED BRANCH DISCHARGE PIPES, SYSTEM III						
APPLIANCE	DIAMETER DN	MIN. TRAP SEAL DEPTH mm	MAX. LENGTH (L) PIPE FROM TRAP OUTLET TO STACK m	PIPE GRADIENT	MAX. NO. OF BENDS	MAX. DROP (H) m
LIMITATIONS FOR UNVENTILATED BRANCH DISCHARGE PIPES, SYSTEM III						
Washbasin, bidet (30mm diameter trap)	30	75	1.7	2.2(1)	0	0
Washbasin, bidet (30mm diameter trap)	30	75	1.1	4.4(1)	0	0
Washbasin, bidet (30mm diameter trap)	30	75	0.7	8.7(1)	0	0
Washbasin, bidet (30mm diameter trap)	40	75	3.0	1.8 to 4.4	2	0
Shower, bath	40	50	No Limit (2)	1.8 to 9.0	No Limit	1.5
Bowl urinal	40	75	3.0 (3)	1.8 to 9.0	No Limit (4)	1.5
Trough urinal	50	75	3.0 (3)	1.8 to 9.0	No Limit (4)	1.5
Slab urinal (3)	60	50	3.0 (3)	1.8 to 9.0	No Limit (4)	1.5
Kitchen sink (40mm diameter trap)	40	75	No Limit (2)	1.8 to 9.0	No Limit	1.5
Household dishwasher or washing machine	40	75	3.0	1.8 to 4.4	No Limit	1.5
WC with outlet up to 80mm (6)	75	50	No Limit	1.8 min	No Limit (4)	1.5
WC with outlet greater than 80mm (6)	100	50	No Limit	1.8 min	No Limit (4)	1.5
Food waste disposal (7)	40 min	75 (8)	3.0 (3)	13.5 min	No Limit (4)	1.5
Sanitary towel disposal unit	40 min	75 (8)	3.0 (3)	5.4 min	No Limit (4)	1.5
Floor drain	50	50	No Limit (3)	1.8 min	No Limit	1.5
Floor drain	50	50	No Limit (3)	1.8 min	No Limit	1.5
Floor drain	100	50	No Limit (3)	1.8 min	No Limit	1.5
4 basins	50	75	4.0	1.8 to 4.4	0	0
Bowl urinals (3)	50	75	No Limit (3)	1.8 to 1.9	No Limit (4)	1.5
Maximum of 8 WC's (9)	100	50	15.0	0.9 to 9.0	2	1.5
Up to 5 spray tap basins (9)	30 max	50	4.5 (3)	1.8 to 4.4	No Limit (4)	0

Table 7.03

- (1) Steeper gradient permitted if pipe is less than maximum permitted length.
- (2) If length is greater than 3m noisy discharge may result with an increased risk of blockage.
- (3) Should be as short as possible to limit problems with deposition.
- (4) Sharp throated bends should be avoided.
- (5) For slab urinal for up to 7 persons. Longer slabs to have more than one outlet.
- (6) Swept-entry branches serving WC's.
- (7) Includes small potato-peeling machines.
- (8) Tubular not bottle or resealing traps.
- (9) Spray tap basins shall have flush-grated wastes without plugs.

VENTILATED DISCHARGE BRANCHES

Sizes and limitations upon the use of ventilated discharge branches are given in tables 7.03 and 7.04. Limitations given in the second table are simplifications, for further information see national and local regulations and practice.

SIZING CHART - VENTILATED BRANCH DISCHARGE PIPES, SYSTEM III						
APPLIANCE	DIAMETER DN	MIN. TRAP SEAL DEPTH mm	MAX. LENGTH (L) PIPE FROM TRAP OUTLET TO STACK m	PIPE GRADIENT	MAX. NO. OF BENDS	MAX. DROP (H) m
LIMITATIONS FOR VENTILATED BRANCH DISCHARGE PIPES, SYSTEM III						
Washbasin, bidet (30mm diameter trap)	30	75	3.0	1.8 min	2	3.0
Washbasin, bidet (30mm diameter trap)	40	75	3.0	1.8 min	No Limit	0
Shower, bath	40	50	No Limit (2)	1.8 min	No Limit	No Limit
Bowl urinal	40	75	3.0 (3)	1.8 min	No Limit (4)	3.0
Trough urinal	50	75	3.0 (3)	1.8 min	No Limit (4)	3.0
Slab urinal (3)	60	50	3.0 (3)	1.8 min	No Limit (4)	3.0
Kitchen sink (40mm diameter trap)	40	75	No Limit (2)	1.8 min	No Limit	No Limit
Household dishwasher or washing machine	40	75	No Limit (3)	1.8 min	No Limit	No Limit
WC with outlet up to 80mm (6) & (14)	75	50	No Limit	1.8 min	No Limit (4)	1.5
WC with outlet greater than 80mm (6) & (14)	100	50	No Limit	1.8 min	No Limit (4)	1.5
Food waste disposal (7)	40 min	75 (8)	3.0 (3)	13.5 min	No Limit (4)	3.0
Sanitary towel disposal unit	40 min	75 (8)	3.0 (3)	5.4 min	No Limit (4)	3.0
Bath drain, floor drain	50	50	No Limit (3)	1.8 min	No Limit	No Limit
Floor drain	70	50	No Limit (3)	1.8 min	No Limit	No Limit
Floor drain	100	50	No Limit (3)	1.8 min	No Limit	No Limit
5 basins (9)	50	75	7.0	1.8 to 4.4	(2)	0
10 basins (9) & (10)	50	75	10.0	1.8 to 1.9	No Limit	0
Bowl urinals (9) & (11)	50	70	No Limit (3)	1.8 min	No Limit (4)	No Limit
More than 8 WC's (6)	100	50	No Limit	0.9 min	No Limit	No Limit
Up to 5 spray tap basins (9)	30 max	50	No Limit (3)	1.8 to 4.4	No Limit (4)	0

Table 7.04

- (1) For maximum distances from trap to vent (see Figure 8 of BS EN 1205-2:2000).
- (2) If length is greater than 3m noisy discharge may result with an increased risk of blockage.
- (3) Should be as short as possible to limit problems with deposition.
- (4) Sharp throated bends should be avoided.
- (5) For slab urinal for up to 7 persons. Longer slabs to have more than one outlet.
- (6) Swept-entry branches serving WC's.
- (7) Includes small potato-peeling machines.
- (8) Tubular not bottle or resealing traps.
- (9) See Figure 9 of BS EN 12056-2:2000.
- (10) Every basin shall be individually ventilated.
- (11) Any number.
- (12) Spray tap basins shall have flush-grated wastes without plugs.
- (13) The size of ventilating pipes to branches from appliances can be DN 25 but, if they are longer than 15m or contain more than five bends, a DN 30 pipe shall be used.
- (14) If the connection of the ventilating pipe is liable to blockage due to repeated splashing or submergence, it should be DN 50, up to 50mm above the spill-over of the appliance.

Site work instructions

STEP 1

Ensure that Terrain Q is cut square to its axis and that all burrs are removed after cutting.

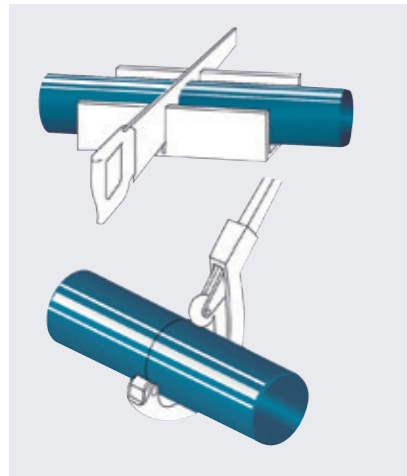

STEP 2

Chamfer the end of the pipe to prevent the ring seal being damaged or misplaced when the pipe is inserted into the socket. Fittings with spigot ends are moulded with a chamfer during manufacture.

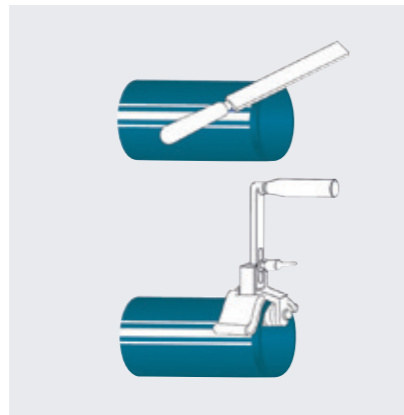

STEP 3

Lubricate the spigot or ring seal with Terrain silicone grease.

STEP 4

Insert the pipe or fitting into the socket and then withdraw it by approximately 10mm to allow for expansion of the pipework.

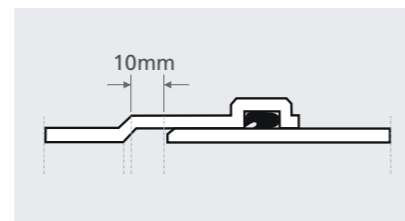

Information tables

Table A: Discharge units (DU) values

TABLE A: DU VALUES	
APPLIANCE	SYSTEM III DU l/s
Wash basin, bidet	0.3
Shower without plug	0.4
Shower with plug	1.3
Single urinal with cistern	0.4
Urinal with flushing valve	-
Slab urinal	0.2*
Bath	1.3
Kitchen sink	1.3
Dishwasher (household)	0.2
Washing machine up to 6kg	0.6
Washing machine up to 12Kg	1.2
WC with 4.0L cistern	**
WC with 6.0L cistern	1.2 to 1.7***
WC with 7.5L cistern	1.4 to 1.8***
WC with 9.0L cistern	1.6 to 2.0***
Floor gully DN 50	-
Floor gully DN 70	-
Floor gully DN 100	-

* Per person.
** Not permitted.
*** Depending upon type (valid for WC's with siphon flush cistern only).
- Not used or no data.

EXAMPLE - 10 STOREY BUILDING WITH:

2 WC	2 x 1.5 = 3.0
4 WHB	4 x 0.3 = 1.2
2 BATHS	2 x 1.3 = 2.6
2 SINKS	2 x 1.3 = 2.6
2 W/MC	2 x 0.6 = 1.2
On each floor	10.6 x 9 = 95.4 DU

Domestic Building Use K = 0.7
0.7 √95.4 = 6.84 l/s
See Table C and D for capacities of pipes.

Table B: Typical frequency factors (K)

TABLE B: FREQUENCY FACTORS	
USAGE OF APPLIANCE	K
Intermittent use, e.g. in dwelling, guest house, office	0.5
Frequent use, e.g. in hospital, school, restaurant, hotel	0.7
Congested use, e.g. in toilets and/or showers open to public	1.0
Special use, e.g. laboratory	1.2

FREQUENCY FACTOR (K)

Typical frequency factors associated with different usage of appliances Table B.

Calculation of flow rate

Waste water flow rate (Q_{ww})

Q_{ww} is the expected flow rate of waste water in a part or in the whole drainage system where only domestic sanitary appliances are connected to the system

Q_{ww} = K√ΣDU where:

Q_{ww} = Waste water flow rate (L/s)
K = Frequency factor
ΣDU = Sum of discharge units.

Table D: Stack with secondary venting

TABLE C: STACK WITH PRIMARY VENT			
STACK & STACK VENT	SECONDARY VENT	SYSTEM I, II, III, IV Q MAX (L/s)	
		SQUARE # ENTRIES	SWEPT ENTRIES
60	50	0.7	0.9
70	50	2.0	2.6
80*	50	2.6	3.4
90*	50	3.5	4.6
100**	50	5.6	7.3
125	70	7.6	10.0
150	80	12.4	18.3
200	100	21.0	27.3

* Minimum size where WC's are connected in system II.
** Minimum size where WC's are connected in system I, III, IV. # Equal branch junctions that are more than 45°, or has a centre line radius less than the internal pipe diameter.

Table C: Stack with only primary vent

TABLE C: STACK WITH PRIMARY VENT		
STACK & STACK VENT	SYSTEM I, II, III, IV Q MAX (L/s)	
	SQUARE # ENTRIES	SWEPT ENTRIES
60	0.5	0.7
70	1.5	2.0
80*	2.0	2.6
90*	2.7	3.5
100**	4.0	5.2
125	5.8	7.6
150	9.5	12.4
200	16.0	21.0

* Minimum size where WC's are connected in system II.
** Minimum size where WC's are connected in system I, III, IV. # Equal branch junctions that are more than 45°, or has a centre line radius less than the internal pipe diameter.

8. Fire Sleeves

Sleeves

The Terrain Firetrap Sleeve is a cost-effective product for the fire stopping of pipe penetrations whilst maintaining similar thermal and acoustic properties as standard mineral fibre insulation. The Terrain Firetrap Sleeve was developed with ease of installation in mind.

The sleeve can be quickly and simply fitted onto the pipe and slid into the penetration ensuring that there are no air gaps around the sleeves by filling with mortar or mastic. In a fire situation, the sleeve expands to fill the available space (15mm max) between the pipe and the penetration and will crush and close off plastic drainage pipes. The pipe forms a solid char preventing the passage of fire and smoke to the adjacent compartment.

APPLICATIONS

For Terrain PVC, Terrain FUZE and Terrain Q above ground drainage through:

- Concrete, masonry or plasterboard partitions
- Concrete floor constructions

FEATURES AND BENEFITS

- **Up to 4 Hour Fire Rating** to BS 476 Part 20, BS EN 1366-3
- Protects pipe above and below the slab
- Cost effective
- One sleeve can replace two collars on a horizontal installation
- Easy installation
- Don't have to drill slab
- No need for mechanical fixings
- No mastic is required between the pipe and fire sleeve, providing a close fit
- Easily cut to size to minimise wastage
- Simple to install without special tools or skills
- Will accept hole irregularities of up to 15mm
- Can be retro-fitted
- **Offers excellent acoustic insulation**
- Maintains the thermal insulation of the pipe through the slab or wall penetration
- Maintains vapour seal of existing insulation
- Allows for thermal movement of pipe

**UP TO
4HR
RATING**

"Terrain Firetrap Sleeve was developed with ease of installation in mind."

PART NO.	PIPE DIA. SUITABLE FOR mm	SLEEVE HOLE DIA. mm	SLEEVE OUTSIDE DIA. mm	LENGTH mm
1925.42	40	42	92 - 104	300
1925.54	50	54	104 - 116	300
1925.76	75	76	126 - 138	300
1925.114	110	114	164 - 176	300
1925.169	160	169	219 - 231	300

Table 8.01

Fire protection for vertical Terrain Q pipework in a NON fire rated duct

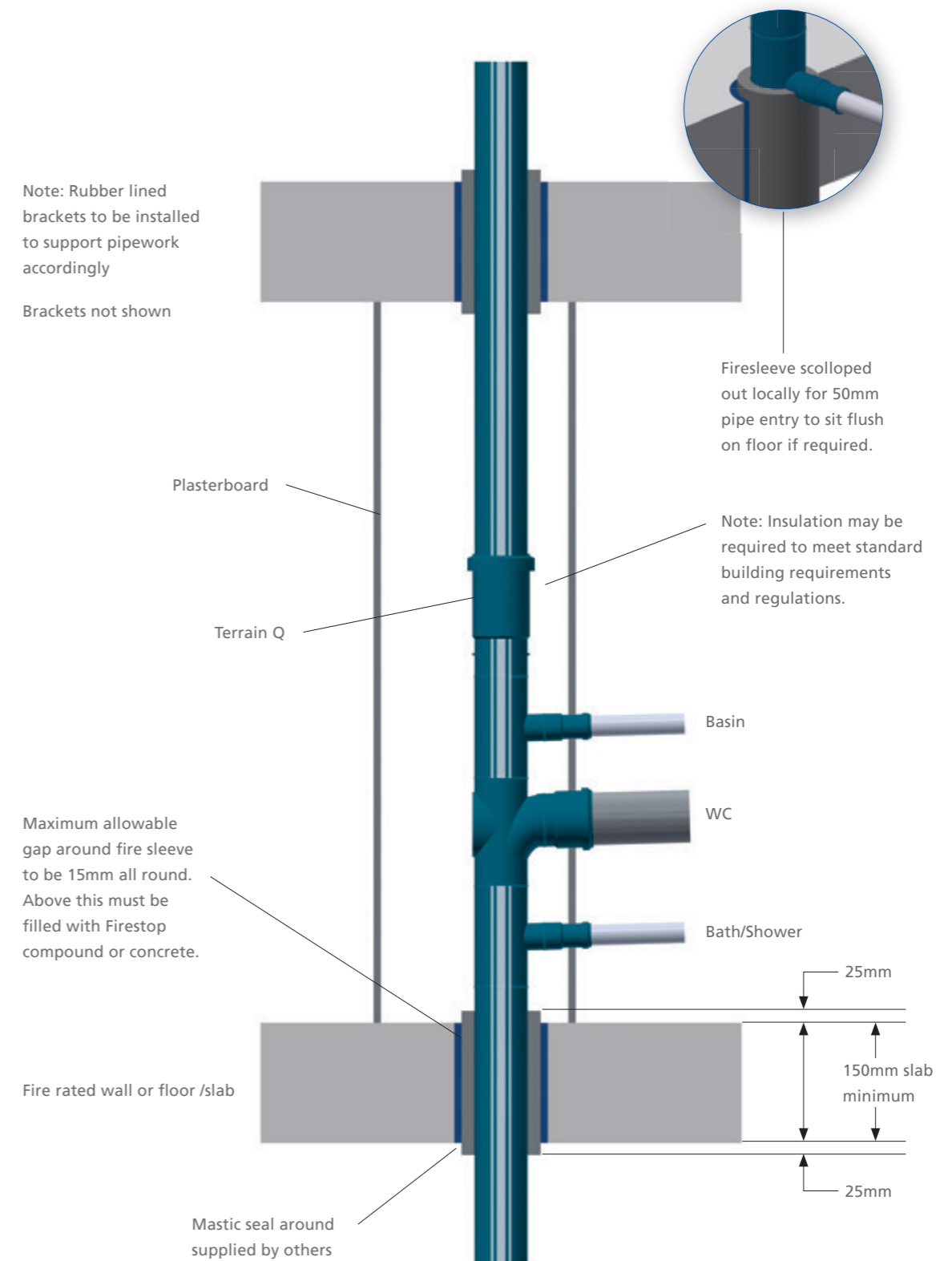

9. System Testing and Maintenance

Terrain Q should be tested in accordance with guidelines stated within **BS EN 12056-2: 2000 (Annex NG.3.1)** which lays out the following:

NG.3 Testing

NG.3.1 AIR TEST

NOTE: Normally this test is carried out to confirm that all pipes and fittings are airtight. It should be completed in one operation but for large multi-storey systems testing in sections may be necessary.

NG.3.1.1 PREPARATION

The water seals of sanitary appliances should be fully charged and test plugs or bags inserted into the open ends of the pipework to be tested. To ensure that there is a satisfactory air seal at the base of the stack, or at the lowest plug or bag in the stack if only a section of the pipework is to be tested, a small quantity of water sufficient to cover the plug or bag can be allowed to enter the system.

One of the remaining test plugs should be fitted with a tee piece, with a cock on each branch, and one branch being connected by means of a flexible tube to a manometer. Alternatively, a flexible tube from a tee piece fitted with cocks on its other two branches can be passed through the water seal of a sanitary appliance. Any water trapped in this tube should be removed and then a manometer can be connected to one of the branches.

NG.3.1.2 APPLICATION

Air is pumped into the system through the other branch of the tee piece until a pressure equal to 38 mm water gauge is obtained. The air inlet cock is then closed and pressure in the system should remain constant for a period of not less than 3 min.

NG.3.1.3 LEAK LOCATION

NOTE: Defects revealed by an air test may be located by the methods given in NG.3.1.3.1, NG.3.1.3.2 and NG.3.1.3.3.

NG.3.1.3.1 SMOKE

A smoke producing machine may be used which will introduce smoke under any pressure into the defective pipework. Leakage may be observed as the smoke escapes. Smoke cartridges containing special chemicals should be used with caution, taking care that the ignited cartridge is not in direct contact with the pipework and that the products of combustion do not have a harmful effect upon the materials used for the discharge pipe system. Smoke testing of plastics pipework should be avoided due to naphtha having a detrimental effect, particularly on ABS, PVC-U and MUPVC. Rubber jointing components can also be adversely affected.

NG.3.1.3.2 SOAP SOLUTION

With the pipework subject to an internal pressure using the smoke machine method as described in NG.3.1.3.1, a soap solution can be applied to the pipes and joints. Leakage can be detected by the formation of bubbles.

NG.3.1.3.3 WATER TEST

There is no justification for a water test to be applied to the whole of the plumbing system. The part of the system mainly at risk is that below the lowest sanitary appliance, and this may be tested by inserting a test plug in the lower end of the pipe and filling the pipe with water up to the flood level of the lowest sanitary appliance, provided that the static head does not exceed 6m.

*For accurate readings, please ensure equipment is regularly checked.

Air pressure test to comply with BS EN 12056-2

For testing a stack with connections

SCREWED TEST PLUG

- Blank or open
- For use in pipe ends
- Manufactured and supplied by others

AIR BAG

- Blank
- For use in access pipe/ expansion socket/pipe ends
- Manufactured and supplied by others

Traps must be filled with water to ensure there is positive pressure within the system to seal the waste inlet.

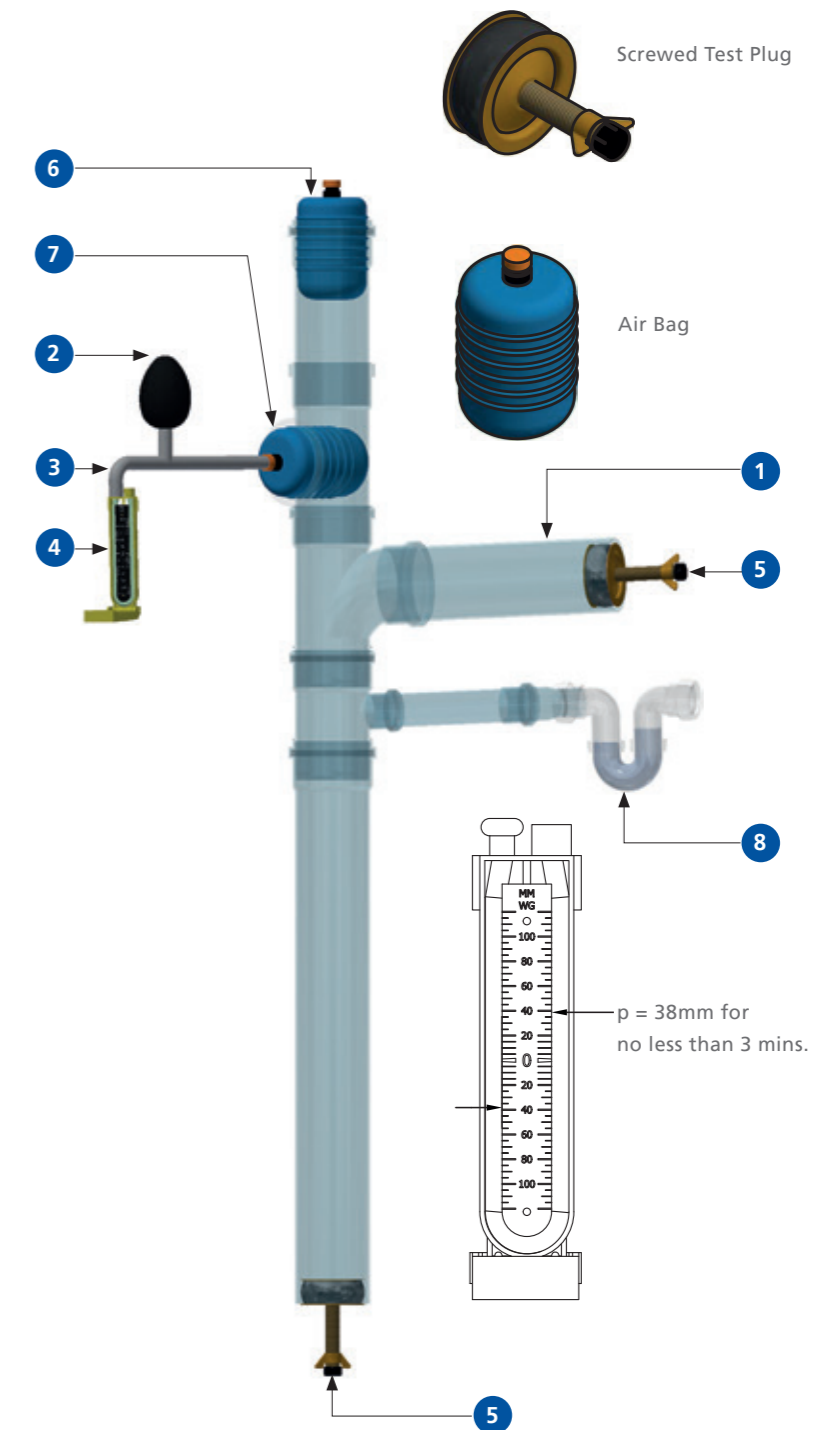

KEY	
NO.	PART
1	Pipework to test
2	Bellow
3	Hose
4	U-Gauge (should read 38mm)
5	Screwed Test Plug
6	Airbag
7	Access point
8	Trap (must be filled with water)

Table 9.01

System maintenance

NG.4.1 GENERAL

Discharge pipe systems should be kept in a clean and sound condition in order to maintain maximum efficiency. This is facilitated by designing in accordance with the recommendations in this national annex.

The following points should be noted:

- When access covers, caps and clearing eyes are removed, damaged packing, ring seals, washers and loose fittings should be renewed before replacement.
- Care should be taken in the use of chemical descaling agents, which are often of a corrosive nature and materials employed in the pipe system should be clearly identified before treatment to ensure that the internal surfaces are not subject to damaging chemical attack.
- Caution is necessary when employing the methods of clearing obstructions which involve the use of air or water at high pressures.
- Hand operated rods for removing blockages in discharge pipes should be capable of passing through the system without damaging the internal surfaces of pipes and fittings.

- Mechanised rodding equipment should only be used by properly trained operators and the pipework to be cleared should be thoroughly examined in advance to enable selection of the appropriate cleaning attachments.
- In renewing paintwork care should be taken to preserve any distinguishing colours which may have been used for identification purposes. Reference should be made to BS 1710.

NG.4.2. DEPOSITS DUE TO MISUSE OF THE DISCHARGE SYSTEM

Completely or partial blockages due to large objects or compacted masses, such as toilet paper and sanitary towels, can usually be loosened by rodding. All such material should be removed from the system at the nearest access point.

NG.4.3 PERIODIC INSPECTION

In addition to general maintenance work, periodic inspections and tests may be advisable to ascertain if there is any misuse or negligence. All defects should be fixed.

10. System Specification

Overview

Terrain Q soil and waste drainage system consists of:

- A range of extruded polypropylene multi-layer pipes
- A range of injection moulded polypropylene composite fittings
- The main jointing method is ring seal jointing
- All pipes and fittings are blue in colour – RAL Code:
Blue external layer RAL 5001
Black intermediate layer RAL 9004
White internal layer RAL 9003

All fittings are manufactured under BS EN 1451. Polypipe Building Services operates and is accredited to the following management systems:

- BS EN ISO 9001 Quality Management Standard
- BS EN ISO14001 Environmental Management Standard
- BS EN ISO 45001 OHSAS (Health and Safety)

All component parts of the system shall be covered by manufacturer's warranty which can be found at the back of the book or in our terms of use section of the website.

OPERATING PRESSURE AND TEMPERATURE

- Terrain Q system is recommended for use as a gravity soil and waste system. It has a nominal pressure rating of 0.5bar.
- Terrain Q system shall work effectively over the temperature range -20°C to +80°C.
- Intermittent temperatures of 97°C can be accommodated for a period of 2 minutes.

SYSTEM SIZING - PIPE

Terrain Q system is supplied in the following metric sizes:

OD mm	40	50	75	110	160	200
ID mm	36.4	46.4	71.2	104.6	152.2	190.2

Table 10.01

TEST RESULTS

ACOUSTIC - BENCHMARK TEST BS EN 14366				
TERRAIN Q	FLOW RATE l/s			
	0.5	1	2	4
Airborne	48	49	52	54
Structure-borne	16	18	19	20

Table 10.02

FIRE - BENCHMARK TEST BS EN 13501				
FIRE CLASSIFICATION	SMOKE EMISSION		PRODUCTION OF FLAMING DROPLETS	
B	-	s	1	d 0
Hardly combustible material. Higher classification can only be achieved with metallic material.	Scarce smoke emission. Highest classification.		No flaming droplets. Highest classification.	

Table 10.03

JOINTING METHODS

The main connection method for Terrain Q is a hydrostatic ring sealed joint. Pipe or fitting spigots are pushed into the ring seal socket.

CONTROL OF THERMAL MOVEMENT

Control of thermal movement must be considered for a Terrain Q system. A fixed point is required every 3m for the Terrain Q system i.e. one socket per 3m run either horizontal or vertical shall be fixed to allow effective control of thermal movement. Control of thermal movement must be considered for a Terrain Q system.

A fixed point is required every 3m for the Terrain Q system i.e. one socket per 3m run either horizontal or vertical shall be fixed to allow effective control of thermal movement and allowing for the coefficient of expansion of 0.08(mm/m/°C).

BRACKET TYPES

All bracket types used in the Terrain Q system shall be specifically designed to reduce the passage of vibration from the pipe/fitting surface in to the structure of the building. This can be achieved by the correct type of rubber lined bracket, the rubber lining being designed to optimise vibration de-coupling or, by de-coupling the connection rod back to the building structure by use of a proprietary anti-vibration bracket back-plate. System brackets are provided within the Terrain Q range and are designed not to over-tighten on to the surface of the pipe; to avoid forming an acoustic bridge. Terrain Q rubberlined brackets reduce dB rating by 17. This is an average as over tightening will reduce the acoustic performance.

FIRE SLEEVES

Where pipes penetrate through fire compartments, built-in Firetrap fire sleeves must be provided in accordance with BS 476 and Building Regulations part B. Fire protection is required to Terrain Q pipework sizes 50mm and above outside diameter, where it passes through a designated fire barrier, compartment walls or floors.

ADAPTING TO OTHER MATERIALS



KEY	
NO.	PART
1	110 Terrain Q PVC Branch
2	Straight boss adaptor
8	Terrain Q to PVC adaptor

Table 10.03



110 PVC single branch
704P.104.92B



Straight boss adaptor
PVC 117.2 or 117.5
(Solvent weld to boss horn)

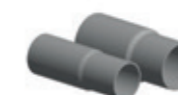

Terrain Q to PVC adaptor

- 6789/DVW 40mm to 1½"
- 6790/DVW 50mm to 2"

11. Support

As the industry moves forward, we're here right by its side. Terrain Q is proof of our commitment to making things simple for our customers, an innovative plastic drainage system that's designed for the future.

Our website also provides useful information to keep you up to date with news and innovations as they happen, including how Terrain Q can further enhance your project.

To find out more visit polypipe.com/terrainQ

Polypipe Building Services

Investing in our business and our people enables us to bring more expertise, more support and more innovation to our customers, helping them to create safe and sustainable commercial buildings, whether newbuild or refurbishment projects.

BUILDING SERVICES SPECIALISM

Having made significant investment in expanding our portfolio to include not only our trusted and well-established Terrain drainage systems, but also MecFlow, our new water supply system, we're committed to working with our customers to provide the best building services solutions for their project. From schools, hospitals and tall buildings to shopping centres, local authorities and commercial and industrial developments, we provide drainage and water supply solutions that help our customers create safe and sustainable services within buildings.

SERVICE AND SUPPORT

Recognising the challenges the construction industry faces, we continuously research and develop products and services that enable us to support our customers more – from working with Engineers to design the best solutions for complex projects to helping Contractors overcome labour shortage issues, a lack of on-site storage and on-site waste management. We develop services to support our customers so that together, we can achieve more.

POLYPIPE ADVANTAGE SERVICE

The Polypipe Advantage service has been specially developed to complement our products and services offering. The Polypipe Advantage team is with you every step of your project, from initial design and project planning, through to manufacture and delivery. By creating fabricated Terrain drainage stacks and MecFlow Kits off-site, we're able to provide our customers quick and more efficient installations on-site. For more information on how the Polypipe Advantage service could benefit your next project, email: buildingservice.technical@polypipe.com

SUPPORTING PRODUCTS AND LITERATURE

With both drainage and water supply systems in its portfolio, Polypipe Building Services has a number of solutions for your next project. More information on these systems can be found at: polypipe.com/commercial-building-services

TAKING YOUR PROJECT FURTHER

As part of the Genuit Group, we have a number of complementary water and climate management systems available to maximise the comfort and efficiency of your commercial building:

Nuaire Ventilation Systems

Our Nuaire brand has been at the forefront of packaged Air Handling Units (AHUs) for over 20 years, designing and manufacturing market leading ranges. Explore the full range of Nuaire ventilation systems at www.nuaire.co.uk.

Polypipe Underfloor Heating

Underfloor heating systems are increasingly popular and are rapidly becoming the heat source of choice for commercial and multioccupancy residential developments. For more information on our range of Underfloor Heating Systems, controls and manifolds visit: www.polypipeUFH.com.

Polypipe: Inspiring Green Urbanisation

To help address the pressures that urbanisation and climate change place on our built environment, we've developed a new generation of technologies that sustain and optimise urban green assets through extended and fully integrated water management solutions. Systems that make space for water, alleviate flooding and capture, store and reuse rainwater, whilst enabling and inspiring Green Urbanisation. www.polypipe.com/civils/gi



Terrain Drainage
+44 (0)1622 795200

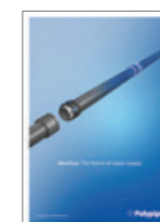

MecFlow
+44 (0)1622 795200



Polypipe Building Services
+44 (0)1622 795200



Polypipe Advantage
+44 (0)1622 795200

All descriptions and illustrations in this publication are intended for guidance only and shall not constitute a 'sale by description'. All dimensions given are nominal and Polypipe may modify and change the information, products and specifications from time to time for a variety of reasons, without prior notice. The information in this publication is provided 'as is' on June 2021. Updates will not be issued automatically. This information is not intended to have any legal effect, whether by way of advice, representation or warranty (express or implied). We accept no liability whatsoever (to the extent permitted by law) if you place any reliance on this publication you must do so at your own risk. All rights reserved. Copyright in this publication belongs to Polypipe and all such copyright may not be used, sold, copied or reproduced in whole or part in any manner in any media to any person without prior consent. Polypipe is a registered trademark of Polypipe. All Polypipe products are protected by Design Right under CDPA 1988. Copyright © 2021 Polypipe. All rights reserved.

12. Approvals

Manufacturing and performance standards

Terrain Q is made to the manufacturing and performance standards stated below.

These standards set out the dimensional, physical and mechanical characteristics that each individual product shall conform to.



MANUFACTURING STANDARDS

BS EN 1451 Plastics piping systems for soil and waste discharge (low and high temperature) within the building structure - Polypropylene (PP).

The system is manufactured in accordance with this standard. The system cannot be kitemarked to the standard as the standard does not currently account for multi-layer pipes.



PERFORMANCE STANDARDS

BS EN 14366 Laboratory measurement of noise from waste water installations. Tested at the Fraunhofer institute to establish the solid-borne and air-borne noise characteristics to known installation and prescribed flow rates.



BS EN 13501 Fire classification of construction products and building elements. Terrain Q achieved a rating of B-s1,d0 which is the highest classification an organic material can achieve.



Terms & Conditions

1. GENERAL

1.1 In these conditions

1.1.1 "the Company" means Polypipe Limited, a company registered in England and Wales with registered number 1099323. Registered office: Broomhouse Lane, Edlington, Doncaster, DN12 1ES, United Kingdom.

1.1.2 "Customer" means the person with whom the Company contracts for the supply of Product pursuant to these conditions;

1.1.3 "Order" means any order submitted to the Company by a Customer;

1.1.4 "Order Confirmation" means any order confirmation submitted to the Customer by the Company;

1.1.5 "Product(s)" means the goods and/or services to be supplied by the Company as referred to and described in an Order which is accepted by the Company;

1.1.6 "Quotation" means the quotation submitted to the Customer by the Company prior to submission of an Order which details the prices at which the Customer may make an offer to purchase the Products;

1.1.7 "Writing" includes telex, cable, facsimile transmission, electronic data transfer and comparable means of communication.

1.2 A contract shall come into force between the Parties each time an Order is accepted by the Company, whether by issuing an Order Confirmation, by delivery, or otherwise, but not before. Subject to clause 1.3, (i) the terms of each contract shall be as set out in these conditions and the terms of any Order accepted by the Company, and (ii) in the event of any conflict between these conditions and any such Order, the terms of the Order shall prevail.

1.3 Save to the extent contemplated at clause 2.1, the parties agree that any terms and conditions submitted at any time by the Customer which have not been written specifically for the purposes of the Product requirement to which a specific Order relates (including, without limitation, any standard terms and conditions of purchase which are printed on any order documentation submitted by the Customer), shall not apply to any contractual dealings between the parties and shall not be deemed to constitute a counter-offer to purchase Products in accordance with those terms unless a specific intention is expressed for such terms and conditions to apply in respect of a specific Order notwithstanding this clause 1.3, and any failure by the Company to challenge or respond to any such terms and conditions does not imply and shall not constitute acceptance of those terms and conditions.

1.4 Unless otherwise stated therein Quotations shall be valid for a maximum period of 30 days from issue and may be withdrawn at any time by written or oral notice.

1.5 Any statement or representation (other than in the Company's Quotation or these terms and conditions) by the Company its servants or agents upon which the Customer wishes to rely must be set out in Writing and attached to or endorsed on the Customer's Order and in any such case the Company may confirm, reject or clarify the point and submit a new Quotation. Any statement or representation which is not so confirmed in Writing is followed or acted upon entirely at the Customer's own risk, and shall not form any part of the contract between the parties, and shall be deemed not to have influenced the Customer in deciding whether to enter into the contract.

1.6 The contract is between the Company and the Customer as principals; neither the benefit nor the burden is assignable by the Customer without the Company's written consent; the contract may be assigned or subcontracted by the Company.

1.7 Unless specifically agreed to the contrary all trade terms shall be interpreted in accordance with current INCOTERMS.

1.8 If, subsequent to any contract of sale which is subject to these conditions, a contract of sale is made with the same Customer without reference to any conditions of sale or purchase, such contract howsoever made shall be deemed to be subject to these conditions or (if different) the standard Conditions of Sale of the Company current at the time when such contract of sale is made.

2. ELECTRONIC TRADING

2.1 If the Company and Customer agree that electronic trading between them shall be a basis for order processing and invoicing then these terms and conditions shall apply subject to any special terms and conditions terms which are specific to electronic trading and which have been agreed by the parties in writing.

2.2 Electronic orders shall be valid if all the information agreed between the Customer and the Company as being required is properly set out in the agreed format and the order is transmitted by the Customer to the Company by reference to the correct identification code and is received by the Company when collecting its electronic mail from the relevant system.

3. DELIVERY

3.1 Unless otherwise agreed in Writing by the Company delivery shall be deemed to take place in the case of ex-works sales when the Products are made available by the Company for collection by the Customer or its carrier and in all other cases upon delivery by the Company to the agreed mainland UK delivery point airport or port but before the Products are unloaded, which shall be the responsibility of the Customer.

3.2 The Company shall not be obliged to make delivery unless and until the Company has received all necessary information, drawings, final instructions and approvals from the Customer and the Customer acknowledges that any

delays or alterations by the Customer may result in delayed delivery for which the Company shall not be responsible.

3.3 All dates and periods for delivery are estimated and do not constitute fixed times for delivery by the Company. Unless such a right or rights are expressly agreed in Writing by the Company, the Customer shall have no right to damages or to cancel the contract for failure arising from any cause to meet any delivery times given in the contract or subsequently set.

3.4 Notwithstanding clause 3.3 the Customer shall be obliged to accept delivery on the date or within the period stated in the Quotation or (if none is so stated) no later than one month after the issue or notice in Writing by the Company requiring the Customer to accept delivery. Failure by the Customer either to take delivery or to make payment in respect of any one or more installments of Products shall entitle the Company to terminate the Contract (such right is without prejudice to any other rights and remedies available to the Company whether expressly provided for in these Conditions or implied by any rule of law).

3.5 Where the Customer requests and the Company agrees to postpone delivery or where delivery is otherwise postponed or delayed without default by the Company, the Customer shall pay upon receipt of written demand from the Company all costs and expenses including a reasonable charge for storage and transportation occasioned thereby and the Customer shall pay for the Products in accordance with these conditions as if the same had been delivered in the ordinary course without reference to the postponement or delay. In addition, the Company shall be entitled to claim interest pursuant to Clause 7.3.2 of these Conditions from the date on which payment would have fallen due, had the Products been delivered in the ordinary course but for the postponement or delay.

3.6 Unless otherwise expressly agreed in Writing the Company may effect delivery in one or more installments. Where delivery is effected by installments each installment shall be treated as a separate contract governed by these conditions. No delay in the delivery of any installment of Products or any defect therein shall entitle the Customer to terminate the remainder of the contract.

4. RISK AND TITLE

4.1 Risk of damage to or loss of the Products shall pass to the Customer upon delivery and the Customer is then solely responsible for all loss damage or deterioration to the Products.

4.2 Title to the Products shall not pass to the Customer until either:-

4.2.1 The Company has received in cash or cleared funds all monies payable (whether or not due) to the Company under this and any other contracts whenever made between the Company and the Customer including contracts made after this contract; or

4.2.2 When the Company serves on the Customer notice in Writing specifying that title in the Products or any part thereof has passed.

4.3 Until title has passed to the Customer the Company may require the Customer to deliver up to the Company all products in respect of which the Company has title and if the Customer fails to do so forthwith the Company's officers, employees, representatives or agents shall be entitled to enter upon any premises where such Products are kept for the purposes of recovering the same.

4.4 Until title to the Products has passed to the Customer pursuant to these conditions it shall possess the Products as fiduciary agent and bailee of the Company and shall store the Products separately from other goods not owned by the Company and shall ensure that they are fully insured on an all risks basis and clearly identifiable as belonging to the Company and the Company shall be entitled to enter upon any premises where such Products are kept for the purpose of satisfying itself that this condition is being complied with by the Customer.

4.5 In the event that the Customer has any contract with any other company under the ultimate control of the parent company that has ultimate control of the Company under which any monies are outstanding (whether or not due) then the Customer shall not (notwithstanding that title would otherwise pass pursuant to Clause 4.2 above) obtain title to the Products or other goods supplied by the Company under this or any other contracts between them until such other company has received in cash or cleared funds all such monies.

5. CANCELLATION AND AMENDMENT

5.1 No contract can be amended or cancelled except with the Company's approval in Writing and should such approval be given the Customer shall indemnify the Company against any costs, losses or expenses resulting from any cancellation or amendment.

6. PRICES

6.1 Unless otherwise agreed in Writing all prices shall be as stated in the valid Quotation or, if no valid Quotation is in place, the Company's prevailing standard price at the time of receipt of an Order, and are for delivery ex works and are exclusive of VAT and any other applicable taxes, which are payable in addition. Unless otherwise stipulated by the Company in Writing prices are payable in Sterling or if the Sterling currency has ceased to exist when the contract is made, shall be payable in such currency as replaces the Sterling currency.

6.2 The Company will endeavour to ensure that all prices on display/provided to Customers are correct and up to date. However, should a Customer place an Order using an incorrect price then the Customer agrees that the Company may substitute the incorrect price set out in the Order for the correct price (whether the price specified on a valid Quotation or the Company's prevailing standard price, as appropriate) and charge accordingly.

6.3 The Company shall be entitled at any time by giving notice in Writing, before or after final invoicing to make a reasonable adjustment to the price in the event of any alteration in quantity, design or specification requested by the Customer.

6.4 The Company reserves the right at any time prior to delivery by giving notice in Writing to increase the price if there is any increase in the cost of materials, labour, transport, or utilities or if the costs of the Company are increased by any other factor beyond the reasonable control of the Company.

6.5 Charges made on the Company's invoice for cases will be credited on their return to the Company's premises carriage paid and in good reusable condition. Cases shown as returnable but not charged on the Company's invoice must be returned to the Company's premises carriage paid and in good re-usable condition otherwise an additional charge will be made in respect of their cost.

6.6 The Customer shall be liable to the Company for any demurrage costs incurred in the event of vehicles being unduly delayed at the point of delivery.

7. TERMS OF PAYMENT

7.1 Unless otherwise agreed by the Company in Writing, the Customer shall make payment by the last day of the month following the month of invoice and the Company shall be entitled to issue invoices in the month in which the Products are delivered or would have been delivered, save for postponement or delay otherwise than due to default on the part of the Company. Time for payment of the price is of the essence of the contract.

7.2 No disputes arising under this contract shall serve to permit payment by the Customer of sums due to the Company to be delayed nor shall disputes interfere with prompt payment in full. The Buyer shall not be entitled to make any deduction from or set off against any sums owing to the Company by reason of any such dispute or at all.

7.3 In the event of default in payment by the Customer the Company shall be entitled, without prejudice to any other right or remedy:

7.3.1 to suspend without notice all further deliveries on this or any other contract between the Company and the Customer;

7.3.2 to charge interest on a daily basis (after as well as before judgement) on any amount outstanding at the rate of 4% above the Base Rate of Lloyds Bank plc from time to time; and/or

7.3.3 to serve notice on the Customer requiring immediate payment for all goods supplied by the company under this and all other contracts between them whether or not payment is otherwise due or invoiced.

8. SPECIFICATIONS

8.1 Subject to Clause 8.2 the Products shall in all material respects be of such specification agreed between the Company and the Customer under the contract, or (if not so agreed) shall be generally in all materials respects in accordance with any published specification issued by the Company.

8.2 The Company reserves the right to make changes in dimensions or other specifications of the Products as are required to conform to applicable standards or laws or are otherwise within reasonable limits having regard to the nature of the Products. Dimensions specified by the Company are to be treated as approximate only unless it is specifically agreed in Writing that exact measurements are required.

8.3 The Customer acknowledges that it has not specified any particular use for the Products and that it is entirely its own responsibility to satisfy itself that the Product is suitable for the use which it intends.

9. LOSS SHORTAGES AND DAMAGE APPARENT ON DELIVERY INSPECTIONS

9.1 The Customer shall have no claim for loss, shortages or damage on delivery which are or would be apparent on inspection unless the Customer:

9.1.1 unpacks and inspects the Products as soon as reasonably practicable following receipt;

9.1.2 notifies the Company of any loss, shortages or damage (otherwise than by a qualified signature on the delivery note) within ten working days of receipt; and

9.1.3 demonstrates to the satisfaction of the Company that such loss, shortages or damage occurred prior to delivery.

9.2 The Customer shall have no rights in respect of loss, shortages or damage unless the Company is given a reasonable opportunity to inspect the Products and investigate any complaint before any use of or alteration to or interference with the Products.

9.3 On a valid complaint made in accordance with this Clause the Customer shall be entitled (in the case of notified shortages) to receive within a reasonable time a delivery of Products equivalent to the shortfall and (in the case of defects) to repairs to or replacements for the affected Products or at the Company's option a credit for the price thereof but the Company shall have no further liability whatsoever. If a complaint of loss, shortages or damage on delivery is not made to the Company in accordance with this Clause 9 within 5 working days of the date of delivery, then the Products shall be deemed to be delivered complete and undamaged in accordance with the contract and the Customer shall be bound to pay for the same accordingly.

9.4 Loss, shortages or damage in a delivery or any installment delivery shall not be a ground for termination of the contract or the remainder of the contract (as the case may be).

10. WARRANTY

10.1 The Company warrants that Products which do not comply with either Clause 8.1 or Sections 13 to 15 of the Sale of Goods Act 1979 (as amended) are shown to have been defective at delivery as a result of faulty design workmanship or materials (other than free-issue materials), shall either be repaired or replaced or that, at the Company's option, a credit or refund for the price thereof shall be given provided always that:

10.1.1 the Company receives written notice of the defect within 12 months of delivery;

10.1.2 no alteration to or interference with the Products takes place before the Company is given access to the Products to inspect and test the same;

10.1.3 the defect does not consist of a loss shortage or damage to which Clause 9 is expressed to apply;

10.1.4 the defect does not arise by reason of a design specification or instruction given by the Customer;

10.1.5 the Customer has not defaulted in its obligation to make payment of the contract price for the Products;

10.1.6 the defect shall not be attributable to incorrect storage or use of the Products by the Customer.

10.2 The benefit of Clause 10.1 shall only extend to Products or parts not manufactured by the Company to the extent that the Company has equivalent recourse against the manufacturer or supplier thereof.

10.3 The Customer shall indemnify the Company in respect of loss or damage arising from any use made of Products after the Customer became or ought reasonably to have been aware of a defect.

10.4 In the event of a valid claim being made in accordance with Clause 10.1:

10.4.1 the Customer shall be bound to accept repaired or replacement Products or at the Company's option credit or repayment and shall not be entitled to terminate the contract;

10.4.2 if the Company does not repair or replace Products within 60 days or such longer time as may be reasonable then the Customer's sole remedy shall be an entitlement to full credit or repayment in respect of the defective Products; and the Company shall be under no further liability in respect of any loss or damage arising from the defect or from any delay before repair replacement credit or refund is effected.

11. LIABILITY

11.1 The Company does not exclude liability arising under Section 12 of the Sale of Goods Act 1979 (good title) (as amended) or for death or personal injury caused by its negligence as defined in the Unfair Contract Terms Act 1977, fraudulent misrepresentation or any other type of liability which cannot by law be excluded or limited

11.2 Save as provided under Clauses 9, 10 and 11.1 the Company shall have no liability to the Customer in connection with or arising from any defect or failure in the Products or otherwise due to the quality, condition, suitability, durability, safety or any other aspect or feature of the Products. The Company's liability, whether in respect of one claim or in the aggregate, shall not exceed the contract price payable under this contract for the supply of Products to be provided under it. The price of the Products is predicated on the basis of the limitations and exclusions set out in these conditions. The Customer acknowledges that without those exclusions and limitations, the price of the Products would be higher and that the limitation of the Company's liability is therefore reasonable in all the circumstances. The Customer agrees that it is its own responsibility to insure adequately to cover any loss or damage in excess of the aforesaid limit of the Company's liability. Subject to reaching agreement on terms, the Company and the Customer may determine an increased level of liability which is to be accepted in Writing by the Company to cover, in particular specific types of loss or damage which both parties reasonably foresee and anticipate.

11.3 In Clause 11.2 the term "liability" means any form of liability whatsoever including but not limited to liability in misrepresentation and under contract, common law, equity and any statutory provision whether or not based on negligence or breach of any express or implied duty to act with care or skill.

11.4 Notwithstanding any other provisions of these conditions the Customer shall have no claim against the Company in respect of any loss other than strictly direct losses (meaning for these purposes the increased costs of purchasing products from a third party or the cost of remedial repair work) and specifically consequential, financial economic loss whether direct or indirect including but not limited to any incidental costs of dismantling fitting or other ancillary work required in connection with the provision of a repair or replacement, any loss or production profits contracts loss of use or anticipated savings and any claims made against the Customer by any third party are excluded even if reasonably foreseeable.

11.5 To the extent that any liability of the Company is expressed to be limited or excluded by these conditions the Customer shall indemnify the Company in respect thereof.

12. CONFIDENTIAL INFORMATION ETC.

12.1 All drawings, documents, records, computer software and other information supplied by the Company are supplied on the express understanding that all intellectual property rights therein is reserved to the Company and that the Customer will not without written consent of the Company either give away, loan, exhibit, or sell the same or extracts therefrom or copies thereof or use the same in any way except in connection with the Products in respect of which they are issued.

13. PATENT INDEMNITIES

13.1 If the Customer is subject to a claim or threatened with any action alleging that the Products in the form supplied infringe any patent, copyright, design right or other intellectual property right then provided that the Customer promptly informs and fully co-operates with the Company and if requested allows the Company the conduct and defence thereof on the Customer's behalf, the Company will indemnify the Customer against any award or damages for infringement made in any such action by a court or other competent body against the Customer. Further, if the Products are infringing the Customer agrees that the company shall have the option at its own expense either to modify the Products so that they do not infringe: to replace the Products with a non-infringing substitute: to procure for the Customer the right for the Customer to continue its use of the Products: or to repurchase the Products from the Customer at the price paid by the Customer less an allowance for the use made thereof.

13.2 The Company shall have no liability in respect of claims for infringement or alleged infringement of third parties patent or other intellectual property rights arising from the manufacture or supply of the Products to the Customer's instructions or in accordance with designs plans or specifications given by the Customer and the Customer shall indemnify the Company against all losses damages expenses costs or other liability arising from such claims.

14. CUSTOMER'S DRAWINGS

14.1 The Customer shall be solely responsible for ensuring that all drawings information advice and recommendations specified or given to the Company by the Customer or its agents, servants, consultants or advisers are accurate correct and suitable. Examination or consideration by the Company of such drawings information advice or recommendations shall not result in any liability on the part of the Company.

15. COMPANY LITERATURE

15.1 The information contained in the advertising, sales, technical, and other literature issued by the Company may be relied upon to be accurate in the exact circumstances in which it is expressed otherwise any illustrations performance details examples of installations and methods of assembly and all other information and data in such literature are based on experience and upon trials under test conditions and are provided for general guidance only. No such information or data shall form part of the contract unless it is specifically referred to in the Quotation.

16. TERMINATION

16.1 Without prejudice to any other rights or remedies of the Company it shall be entitled in any of the following circumstances to terminate (in whole or in part) this and any other contract whenever made between the Company and the Customer and/or to suspend deliveries and/or to receive upon demand payment of all monies payable under any such contracts whether or not otherwise due:

16.1.1 the Customer made or proposes any voluntary arrangement with its creditors or becomes subject to an administration order or becomes bankrupt or goes into liquidation;

16.1.2 an encumbrancer takes possession or a receiver is appointed of any of the property or assets of the Customer;

16.1.3 the Customer becomes unable to satisfy its debts as they fall due or cease, or threatens to cease to carry on business;

16.1.4 the Company reasonably believes that any of the events mentioned above or any equivalent or similar event under any relevant laws to which the Customer or any connected person is subject has or may occur;

16.1.5 the Customer or any connected person commits any breach of this or any other contract whenever made between the Customer and the Company.

17. FORCE MAJEURE

17.1 The Company shall be excused performance of its obligations whilst and if affected by act of God governmental restriction condition or control, any act done or not done pursuant to a trade dispute whether such dispute involves its employees or not, default by suppliers of the Company, shortage of materials or by any other act matter or thing beyond its reasonable control including failure by the other party to carry out anything required for performance of the contract.

17.2 In the event that the Company does not perform its obligations by reason of any of the causes referred to in Clause 17.1 within six months after the time for performance then the Company or the Customer may by written notice terminate the contract without liability save that the Customer shall pay for any Products delivered or completed at the time of termination.

18. TOOLS

18.1 Any tools (such as jigs, dies, etc) which the Company may construct or acquire specifically in connection with the Products shall, notwithstanding any charges the Company may make for them, be and remain the Company's sole and unencumbered property and in the Company's possession and control without restriction.

19. FREE-ISSUE MATERIAL

19.1 Free-issue material shall be insured by and remain at the risk of the Customer at all times and the Company shall be indemnified by the Customer against any loss, damage, injury or expense whatsoever arising directly or indirectly therefrom and the company shall not be liable for loss of or damage to any such materials during fabrication by the Company or sub-contractor employed by Company or whilst on the premises of the Company or of any such sub-contractor or in transit to or from the premises of the Company or of any such sub-contractor provided that the Company may at its sole discretion make a contribution towards the replacement costs of such materials.

19.2 An allowance for material lost as process scrap is (where applicable) included in the contract price and no such losses shall be the subject of any claim by the Customer or contribution by the Company.

19.3 Where materials are supplied by or on behalf of the Company the Customer shall be responsible to ensure that the material is of satisfactory quality and is fit for its purpose and shall indemnify be Company against any loss damage, injury or expenses whatsoever arising directly or indirectly from any fault in or incorrect specification of the said materials.

20. CONSUMER PROTECTION ACT 1987

20.1 Where the Customer purchases the Products for use or incorporation with any other products to be assembled, produced, processed packed or supplied by the Customer or for resale or supply ancillary to any such other products or other products supplied by the Customer then:

20.1.1 the Customer shall forthwith on demand produce for inspection by the Company copies of all written instructions information and warnings to be supplied by the Customer in relation thereto provided nevertheless that such inspection or right to inspect shall not give rise to any responsibility or liability on the part of the Company; and

20.1.2 the Customer shall indemnify the Company against any losses, costs and damages that the Company may suffer or incur in the event any claim is made against the Company in relation thereto if the Products did not comprise the defective element thereof or were rendered defective by reason of actions or omissions of the Customer (including without limitation the supply of defective free-issue materials) or were rendered defective by reason of instructions or warnings given or omitted by the Customer or other reseller.

20.2 For the purpose of Clause 20.1 the term "defective" shall be interpreted in accordance with the definition contained in Part 1 of the Consumer Protection Act 1987.

21. HEALTH & SAFETY

21.1 The Customer agrees to pay due regard to any information supplied by the Company relating to the use for which the Products are designed or have been tested or concerning conditions necessary to ensure that they will be safe and without risk to health at all times when they are being set, used, cleaned, serviced or maintained by any person and the Customer undertakes to take such steps as may be specified by such information or otherwise necessary to ensure that as far as is reasonably practicable the Products will be safe and without risk to health at all times as mentioned above.

22. LAW AND JURISDICTION ETC.

22.1 The Contract shall be governed and interpreted exclusively according to the Laws of England. The parties hereby agree to submit to the exclusive jurisdiction of the English courts provided that the Company may at its option take proceedings in the courts of the state in which the Customer is domiciled including action to obtain any remedy (including injunctive relief). In the case of any order for the export of Products, the Schedule to the Uniform Law on International Sales Act 1967 shall not in any circumstances apply to the Contract and neither shall the limits imposed by the Unfair Contract Terms Act 1977 on the extent to which liability can be excluded or limited.

22.2 No waiver of or delay or failure by the Company to exercise any rights or remedies shall prejudice or preclude any future or further exercise thereof.

22.3 If any provision of these conditions shall be held invalid or unenforceable in whole or in part then the unaffected provisions shall remain in full force and effect. Headings appear for convenience only and shall not affect the Construction of these conditions.

22.4 If the Contract provides for the supply of services and no general conditions of the Company relating specifically to the supply of services are made applicable to such services then these conditions shall mutatis mutandis apply to such services as they would apply to Products and in such event Clause 10.1 will be deemed to include a reference to Sections 3 to 5 of the Supply of Goods and Services Act 1982 (as amended), either in addition to or in place of the reference to Sections 13 to 15 of the Sale of Goods Act 1979 (as amended) as may be appropriate. For the avoidance of doubt the following provisions apply where the Company supplies services to the Customer in accordance with clause 22.4:-

22.4.1 the Company's obligation to provide the services is in any event conditional upon payment of the agreed price for the services. Any default or delay in payment according to the terms agreed between the Company and the Customer shall entitle the Company at its option to decline to perform or decline to continue to perform its obligations hereunder but without thereby incurring any liability to the Customer.

22.4.2 Save to the extent that by reason of negligence on the part of the Company in the performance of the services which results in death or personal injury (which the Company does not limit or exclude), the Company's liability under the contract shall be limited to the amount of charges paid to the Company in return for the services and in particular the Company accepts responsibility only for direct and unavoidable loss or damage arising from any negligence in the provision of services and in particular all other types of loss whether economic, financial, indirect or consequential and whether reasonably foreseeable or not are excluded to the fullest extent permitted by law.

22.4.3 The Customer shall lend all such reasonable assistance to the Company in the performance of the services as the Company shall reasonably require.

22.4.4 The Customer shall indemnify and keep the Company, its employees, agents and contractors indemnified at all times from and against any loss or damage and injury caused to persons or property in the course of the provision of the services where such loss or damage arises by reason of the Customer's negligence or negligence of persons under the control of the Customer.

22.4.5 The Customer acknowledges and agrees that if due to the act or omission of the Customer, the Company is not able, having attended at the Customer's premises to perform the services, the Company shall be entitled to claim reasonable additional costs and expenses from the Customer occasioned by any resulting delay in the provisions of the services.

22.5 In cases for the sale or supply of Products overseas, the following additional provisions shall apply unless otherwise stipulated in writing by the Company:

22.5.1 the Customer shall be solely responsible for obtaining all necessary import authorisations, the payment of any applicable import taxes, duties or imposts and the Company shall be under no obligation to give the Customer the notice specified in Section 32(3) of the Sale of Goods Act 1979 (or any re-enactment thereof);

22.5.2 Quotations issued in a currency other than Sterling may at the Company's option, unless otherwise agreed in writing, be subject to amendment in the event of fluctuations in the applicable exchange rate prior to the date of invoice;

22.5.3 payment in respect of Products for export is due on the date specified by the Company at the date when the Contract is made, in the currency stated in the invoice and in accordance with the method of payment stipulated by the Company. All costs incurred by the Company in connection with the designated particular method of payment shall be met by the customer.

22.5.4 If you are a consumer within the meaning of the Distance Selling Regulations 2000 and you have bought the products detailed overleaf over telephone, internet or via mail order then within seven days of receipt of you products you have the right to cancel your order and return the Products for a full refund. Trading terms were accurate at point of publication, to check for updates, please go to Trading Terms & Conditions at www.Polypipe.com/trading-terms-conditions.

Terrain Q.

Design, specification
and installation guide

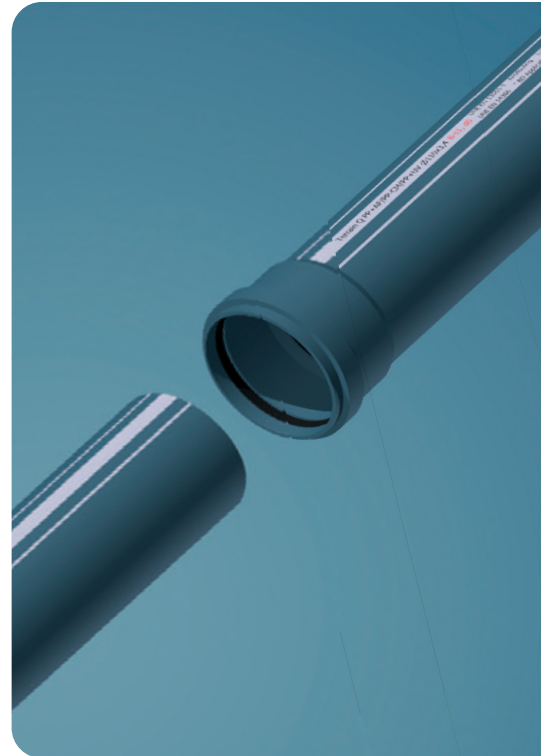

Polypipe Building Services

New Hythe Business Park
College Road
Aylesford
Kent
ME20 7PJ

Tel +44 (0) 1622 795200

Fax +44 (0) 1622 7167965

Email commercial.buildingservices@polypipe.com

www.polypipe.com/TerrainQ