

## Polypipe Ltd

New Hythe Business Park  
College Road  
Aylesford  
Kent ME20 7PJ

Tel: 01622 795 200

e-mail: [commerciaLENquiries@polypipe.com](mailto:commerciaLENquiries@polypipe.com)

website: [www.polypipe.com](http://www.polypipe.com)



**Agrément Certificate**

**07/4479**

Product Sheet 1

## TERRAIN HDPE DRAINAGE SYSTEMS

### TERRAIN FUZE DRAINAGE SYSTEM

This Agrément Certificate Product Sheet<sup>(1)</sup> relates to the Terrain FUZE Drainage System, comprising a range of pipes and fittings manufactured from high-density polyethylene (HDPE), for use in domestic, commercial and public buildings.

(1) Hereinafter referred to as 'Certificate'.

#### CERTIFICATION INCLUDES:

- factors relating to compliance with Building Regulations where applicable
- factors relating to additional non-regulatory information where applicable
- independently verified technical specification
- assessment criteria and technical investigations
- design considerations
- installation guidance
- regular surveillance of production
- formal three-yearly review.



#### KEY FACTORS ASSESSED

**Strength** — the pipes and fittings have adequate strength to resist the loads associated with installation and service (see section 6).

**Performance of joints** — the system will remain watertight under normal service conditions (see section 7).

**Durability** — the system will have a service life in excess of 50 years (see section 13).

The BBA has awarded this Certificate to the company named above for the system described herein. This system has been assessed by the BBA as being fit for its intended use provided it is installed, used and maintained as set out in this Certificate.

On behalf of the British Board of Agrément

Date of Third issue: 10 July 2018

Paul Valentine  
Technical Excellence Director

Originally certificated on 26 November 2008

Claire Curtis-Thomas  
Chief Executive

*Certificate amended on 11 December 2018 to update company details and system name.*

*The BBA is a UKAS accredited certification body – Number 113.*

*The schedule of the current scope of accreditation for product certification is available in pdf format via the UKAS link on the BBA website at [www.bbacerts.co.uk](http://www.bbacerts.co.uk)  
Readers are advised to check the validity and latest issue number of this Agrément Certificate by either referring to the BBA website or contacting the BBA direct.  
Any photographs are for illustrative purposes only, do not constitute advice and should not be relied upon.*

#### British Board of Agrément

Bucknalls Lane  
Watford  
Herts WD25 9BA

©2018

tel: 01923 665300  
[clientservices@bbacerts.co.uk](mailto:clientservices@bbacerts.co.uk)  
[www.bbacerts.co.uk](http://www.bbacerts.co.uk)

## Regulations

In the opinion of the BBA, the Terrain FUZE Drainage System, if installed, used and maintained in accordance with this Certificate, can satisfy or contribute to satisfying the relevant requirements of the following Building Regulations (the presence of a UK map indicates that the subject is related to the Building Regulations in the region or regions of the UK depicted):



### The Building Regulations 2010 (England and Wales) (as amended)

<b>Requirement:</b>	<b>H1</b>	<b>Foul water drainage</b>
Comment:		The system will convey the flow of foul water and minimise the risk of blockage or leakage. See sections 4, 6, 7, 8 and 10 of this Certificate.
<b>Requirement:</b>	<b>H3(1)</b>	<b>Rainwater drainage</b>
Comment:		The system will convey the flow of surface water and minimise the risk of blockage or leakage. See sections 4, 6, 7, 8, 9 and 10 of this Certificate.
<b>Regulation:</b>	<b>7</b>	<b>Materials and workmanship</b>
Comment:		The system is acceptable. See section 13 and the <i>Installation</i> part of this Certificate.



### The Building (Scotland) Regulations 2004 (as amended)

<b>Regulation:</b>	<b>8(1)(2)</b>	<b>Durability, workmanship and fitness of materials</b>
Comment:		The use of the system satisfies the requirements of this Regulation. See sections 12 and 13 and the <i>Installation</i> part of this Certificate.
<b>Regulation:</b>	<b>9</b>	<b>Building standards applicable to construction</b>
Standard:	3.6(a)	Surface water drainage
Comment:		The system will satisfy the relevant requirements of this Standard, with reference to clause 3.6.1 <sup>(1)(2)</sup> . See sections 4 and 9 of this Certificate.
Standard:	3.7(b)(c)	Wastewater drainage
Comment:		The system will satisfy the relevant requirements of this Standard, with reference to clause 3.7.1 <sup>(1)(2)</sup> . See sections 9, 10 and 12 of this Certificate.
Standard:	3.10	Precipitation
Comment:		The system satisfies the relevant requirements of this Standard, with reference to clauses 3.10.1 <sup>(1)(2)</sup> and 3.10.6 <sup>(1)(2)</sup> . See section 7 of this Certificate.
Standard:	7.1(a)	Statement of sustainability
Comment:		The system can contribute to meeting the relevant requirements of Regulation 9, Standards 1 to 6, and therefore will contribute to a construction meeting a bronze level of sustainability as defined in this Standard.
<b>Regulation:</b>	<b>12</b>	<b>Building standards applicable to conversions</b>
Comment:		The system can contribute to meeting the relevant requirements of Regulation 9, Standards 1 to 6, and therefore will contribute to a construction meeting a bronze level of sustainability as defined in this Standard.

(1) Technical Handbook (Domestic).

(2) Technical Handbook (Non-Domestic).



### The Building Regulations (Northern Ireland) 2012 (as amended)

<b>Regulation:</b>	<b>23</b>	<b>Fitness of materials and workmanship</b>
Comment:		The system is acceptable. See section 13 and the <i>Installation</i> part of this Certificate.

<b>Regulation:</b>	<b>79</b>	<b>Drainage systems</b>
Comment:		The system satisfies the relevant requirements of this Regulation. See sections 4 and 7 of this Certificate.
<b>Regulation:</b>	<b>80</b>	<b>Sanitary pipework</b>
Comment:		The system satisfies the relevant requirements of this Regulation. See section 4 of this Certificate.
<b>Regulation:</b>	<b>82</b>	<b>Rain-water drainage</b>
Comment:		The system satisfies the relevant requirements of this Regulation. See sections 4, 9 and 10 of this Certificate.

## Construction (Design and Management) Regulations 2015 Construction (Design and Management) Regulations (Northern Ireland) 2016

Information in this Certificate may assist the client, designer (including Principal Designer) and contractor (including Principal Contractor) to address their obligations under these Regulations.

See sections: 3 *Delivery and site handling* (3.1) and 14 *Procedure* of this Certificate.

### Additional Information

#### NHBC Standards 2018

In the opinion of the BBA, the Terrain FUZE Drainage System, if installed, used and maintained in accordance with this Certificate, can satisfy or contribute to satisfying the relevant requirements in relation to *NHBC Standards Part 5 Substructure, ground floors, drainage and basements, Chapter 5.3 Drainage below ground, and Part 8 Services, Chapter 8.1 Internal services.*

### Technical Specification

#### 1 Description

1.1 The Terrain FUZE Drainage System comprises pipes and fittings and is used above ground in buildings to evacuate sanitary waste and soil products. The system components are black in colour and the pipes are produced in 3 and 5 m lengths. Other suitable lengths are available by special order, but are outside the scope of this Certificate.

1.2 The nominal outside diameters and wall thicknesses of the pipes are given in Table 1.

1.3 The dimensions of the fittings are given in Tables 2 to 42. The types of fittings available are:

- 90° bend
- 90° bend (fabricated)
- 88.5° bend
- 45° bend
- 45° bend (fabricated)
- 45° equal branch
- 88.5° equal branch
- 135° reducing branch
- 88.5° swept branch
- 135° double branch
- 88.5° equal branch
- Corner boss branch
- Corner branch
- 3-way branch
- 4-way branch
- Single boss pipe
- Double branch
- 180° double branch ball
- 90° double branch ball
- 135° double branch ball
- 90° 3-way branch ball
- 135° 3-way branch ball
- 90° 4-way branch ball
- Low level manifold
- Short ring seal socket
- Ring seal socket
- Expansion joint
- Concentric reducer
- Compression joint
- Stop end
- Weld on cap 40-125mm
- Weld on cap 160-315mm
- Anchor Pipes
- Access pipe
- 45° access pipe
- Electrofusion coupling
- Sliding connector
- Ring seal socket
- Eccentric reducer
- Long eccentric reducer
- Ventilation branch.

**Table 1 HDPE soil and waste pipes**

Pipe length (L) (m)	OD <sup>(1)</sup> (Ø) (mm)	Internal diameter (Di) (mm)	Wall thickness (S) (mm)	Cross-sectional area (A) (cm <sup>2</sup> )	Mass (kg·m)	Part no.
3	40	34	3	9	0.37	900.40.30B
3	50	44	3	15.2	0.46	900.50.30B
3	56	50	3	19.6	0.53	900.56.30B
3	63	57	3	25.4	0.595	900.63.30B
3	75	69	3	37.3	0.74	900.75.30B
3	90	83	3.5	54.1	0.98	900.90.30B
3	110	101.4	4.3	80.7	1.45	900.110.30B
3	125	115.2	4.9	104.5	1.86	900.125.30B
3	160	147.6	6.2	171.1	3.08	900.160.30B
5	40	34	3	9	0.37	900.40.50B
5	50	44	3	15.2	0.46	900.50.50B
5	56	50	3	19.6	0.53	900.56.50B
5	63	57	3	25.4	0.595	900.63.50B
5	75	69	3	37.3	0.74	900.75.50B
5	90	83	3.5	54.1	0.98	900.90.50B
5	110	101.4	4.3	80.7	1.45	900.110.50B
5	125	115.2	4.9	104.5	1.86	900.125.50B
5	160	147.6	6.2	171.1	3.08	900.160.50B
5	200	187.6	6.2	276.4	4.1	900.200.50B
5	250	234.4	7.8	431.5	6.1	900.250.50B
5	315	295.4	9.8	685.3	9.51	900.315.50B

(1) OD = outside diameter.

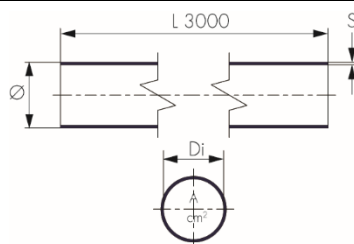

Note: Dimension 'L' in the above diagram is in mm.

Table 2 90° bend

OD <sup>(1)</sup> ( $\varnothing$ ) (mm)	Wall thickness (S) (mm)	Length (L1) (mm)	Length (L2) (mm)	Radius of bend (R) (mm)	Length of straight (K)	Weight (kg)	Part no.
40	3	150	30	30	120	0.07	907.40.90B
50	3	180	40	40	140	0.095	907.50.90B
56	3	210	40	40	170	0.12	907.56.90B
63	3	210	50	50	160	0.145	907.63.90B
75	3	210	70	70	140	0.18	907.75.90B
90	3.5	240	90	90	150	0.28	907.90.90B
110	4.3	270	100	100	170	0.49	907.110.90B
125	4.9	200	110	110	90	0.49	907.125.90B
160	6.2	140	140	140	0	0.69	907.160.90B

(1) OD = outside diameter.

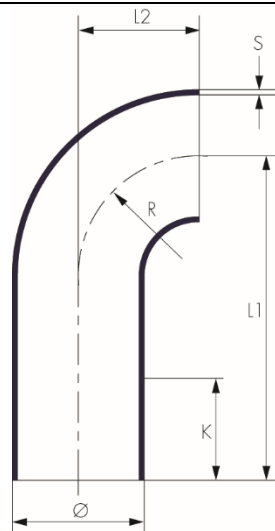
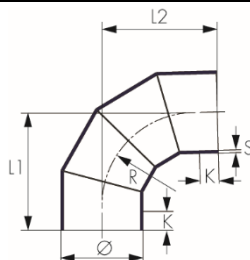

Table 3 90° bend (fabricated)

OD <sup>(1)</sup> ( $\varnothing$ ) (mm)	Wall thickness (S) (mm)	Length (L1) (mm)	Length (L2) (mm)	Radius of bend (R) (mm)	Length of straight (K)	Weight (kg)	Part no.
200 <sup>(2)</sup>	6.2	300	300	240	75	1.745	907.200.90B
250 <sup>(2)</sup>	7.8	335	335	320	30	3.4	907.250.90B
315 <sup>(2)</sup>	9.8	370	370	350	30	5.89	907.315.90B

(1) OD = outside diameter.

(2) Welded.



**Table 4 91.5° (88.5) bend**

OD <sup>(1)</sup> (∅) (mm)	Wall thickness (S) (mm)	Length (L) (mm)	Length of straight (K)	Weight (kg)	Part no.
40	3	50	20	0.035	901.40.92B
50	3	60	20	0.05	901.50.92B
56	3	65	20	0.06	901.56.92B
63	3	70	20	0.075	901.63.92B
75	3	75	20	0.095	901.75.92B
90	3.5	80	20	0.135	901.90.92B
110	4.3	95	25	0.23	901.110.92B
125	4.9	103	35	0.33	901.125.92B
160	6.2	123	35	0.7	901.160.92B

(1) OD = outside diameter.

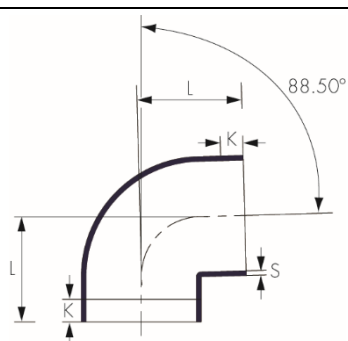

**Table 5 45° bend**

OD <sup>(1)</sup> (∅) (mm)	Wall thickness (S) (mm)	Length (L1) (mm)	Length of straight (K)	Weight (kg)	Part no.
40	3	45	20	0.03	901.40.135B
50	3	45	20	0.04	901.50.135B
56	3	45	20	0.045	901.56.135B
63	3	50	20	0.06	901.63.135B
75	3	50	20	0.07	901.75.135B
90	3.5	55	20	0.11	901.90.135B
110	4.3	60	25	0.17	901.110.135B
125	4.9	65	25	0.245	901.125.135B
160	6.2	69	20	0.43	901.160.135B

(1) OD = outside diameter.

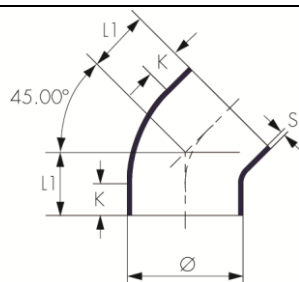

**Table 6 45° bend (fabricated)**

OD <sup>(1)</sup> (∅) (mm)	Wall thickness (S) (mm)	Length (L) (mm)	Radius of bend (R) (mm)	Length of straight (K)	Weight (kg)	Part no.
200 <sup>(2)</sup>	6.2	180	420	75	1.33	901.200.135B
250 <sup>(2)</sup>	7.8	185	430	30	2.15	901.250.135B
315 <sup>(2)</sup>	9.8	185	440	30	3.4	901.315.135B

(1) OD = outside diameter.  
(2) Welded.

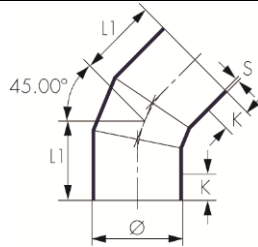

**Table 7 45° equal branch**

OD <sup>(1)</sup> (∅) (mm)	OD <sup>(1)</sup> (∅1) (mm)	Wall thickness (S) (mm)	Length (L) (mm)	Length (L1) (mm)	Length (L2) (mm)	Length (L3) (mm)	Length of straight (K1)	Length of straight (K2)	Length of straight (K3)	Weight (kg)	Part no.
40	40	3	135	45	90	90	25	30	30	0.07	904.40.135B
50	50	3	165	55	110	110	35	20	20	0.105	904.50.135B
56	56	3	180	60	120	120	40	25	25	0.13	904.56.135B
63	63	3	195	65	130	130	40	25	25	0.155	904.63.135B
75	75	3	210	70	140	140	40	25	25	0.205	904.75.135B
90	90	3.5	240	80	160	160	50	20	20	0.32	904.90.135B
110	110	4.3	270	90	180	180	55	20	20	0.53	904.110.135B
125	125	4.9	300	100	200	200	60	20	20	0.765	904.125.135B
160	160	6.2	375	125	250	250	75	25	25	1.475	904.160.135B
200 <sup>(2)</sup>	200	6.2	540	180	360	360	85	10	10	2.99	904.200.135B
250 <sup>(2)</sup>	250	7.8	660	220	440	440	115	55	55	5.8	904.250.135B
315 <sup>(2)</sup>	315	9.8	840	280	560	560	160	95	95	11.1	904.315.135B

(1) OD = outside diameter.  
(2) Welded.

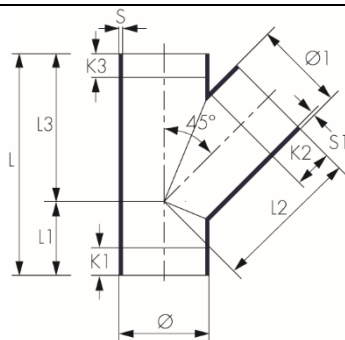

Table 8 88.5°equal branch

OD <sup>(1)</sup> (Ø) (mm)	OD <sup>(1)</sup> (Ø1) (mm)	Wall thickness (S) (mm)	Length (L) (mm)	Length (L1) (mm)	Length (L2) (mm)	Length (L3) (mm)	Length of straight (K1)	Length of straight (K2)	Weight (Kg)	Part no.
40	40	3	130	75	55	55	45	20	0.060	904.40.90B
50	50	3	150	90	60	60	55	25	0.085	904.50.90B
56	56	3	175	105	70	70	65	30	0.105	904.56.90B
63	63	3	175	105	70	70	60	25	0.120	904.63.90B
75	75	3	175	105	70	70	55	25	0.145	904.75.90B
90	90	3.5	200	120	80	80	65	25	0.220	904.90.90B
110	110	4.3	225	135	90	90	65	20	0.365	904.110.90B
125	125	4.9	250	150	100	100	70	20	0.510	904.125.90B
160	160	6.2	350	210	140	140	105	30	1.190	904.160.90B
200 <sup>(2)</sup>	200	6.2	360	180	180	180	25	30	1.705	904.200.90B
250 <sup>(2)</sup>	250	7.8	440	220	220	220	40	40	3.100	904.250.90B
315 <sup>(2)</sup>	315	9.8	560	280	280	280	70	65	6.150	904.315.90B

(1) OD = outside diameter.

(2) Welded.

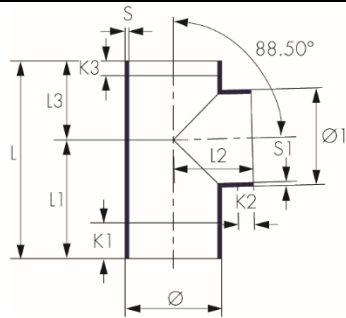



Table 9 135° reducing branch

OD <sup>(1)</sup> (Ø) (mm)	OD <sup>(1)</sup> (Ø1) (mm)	Wall thickness (S) (mm)	Length (L) (mm)	Length (L1) (mm)	Length (L2) (mm)	Length (L3) (mm)	Length of straight (K1)	Length of straight (K2)	Length of straight (K3)	Wall thickness (S1) (mm)	Weight (kg)	Part no.
50	40	3	165	55	110	110	40	45	45	3	0.1	904.5040.135B
56	50	3	180	60	120	120	40	30	30	3	0.125	904.5650.135B
63	40	3	195	65	130	130	40	30	30	3	0.105	904.6340.135B
63	50	3	195	65	130	130	40	30	30	3	0.15	904.6350.135B
63	56	3	195	65	130	130	40	25	25	3	0.18	904.6356.135B
75	40	3	210	70	140	140	60	30	40	3	0.15	904.7540.135B
75	50	3	210	70	140	140	60	30	40	3	0.19	904.7550.135B
75	56	3	210	70	140	140	55	25	35	3	0.19	904.7556.135B
75	63	3	210	70	140	140	55	25	35	3	0.19	904.7563.135B
90	40	3.5	240	80	160	160	80	40	50	3	0.27	904.9040.135B
90	50	3.5	240	80	160	160	80	40	50	3	0.275	904.9050.135B
90	56	3.5	240	80	160	160	75	35	45	3	0.275	904.9056.135B
90	63	3.5	240	80	160	160	65	30	25	3	0.275	904.9063.135B
90	75	3.5	240	80	160	160	65	30	25	3	0.3	904.9075.135B
110	40	4.3	270	90	180	180	95	50	55	3	0.45	904.11040.135B
110	50	4.3	270	90	180	180	95	50	55	3	0.44	904.11050.135B
110	56	4.3	270	90	180	180	90	40	45	3	0.455	904.11056.135B
110	63	4.3	270	90	180	180	80	35	40	3	0.455	904.11063.135B
110	75	4.3	270	90	180	180	75	30	35	3	0.47	904.11075.135B
110	90	4.3	270	90	180	180	65	25	30	3.5	0.485	904.11090.135B
125	40	4.9	300	100	200	200	95	45	50	3	0.61	904.12540.135B
125	50	4.9	300	100	200	200	95	45	50	3	0.63	904.12550.135B
125	56	4.9	300	100	200	200	95	45	50	3	0.63	904.12556.135B
125	63	4.9	300	100	200	200	95	40	50	3	0.585	904.12563.135B
125	75	4.9	300	100	200	200	95	40	50	3	0.63	904.12575.135B
125	90	4.9	300	100	200	200	80	35	30	3.5	0.65	904.12590.135B
125	110	4.9	300	100	200	200	70	25	25	4.3	0.7	904.125110.135B
160	75	6.2	375	125	250	250	110	45	55	3	1.25	904.16075.135B
160	90	6.2	375	125	250	250	110	45	55	3.5	1.25	904.16090.135B
160	110	6.2	375	125	250	250	110	45	55	4.3	1.25	904.160110.135B
160	125	6.2	375	125	250	250	100	40	50	4.9	1.3	904.160125.135B
200 <sup>(2)</sup>	75	6.2	540	180	360	360	150	140	65	3	2.3	904.20075.135B
200 <sup>(2)</sup>	90	6.2	540	180	360	360	150	140	65	3.5	2.3	904.20090.135B
200 <sup>(2)</sup>	110	6.2	540	180	360	360	150	140	65	4.3	2.4	904.200110.135B
200 <sup>(2)</sup>	125	6.2	540	180	360	360	140	130	55	4.9	2.5	904.200125.135B
200 <sup>(2)</sup>	160	6.2	540	180	360	360	115	85	35	6.2	2.7	904.200160.135B
250 <sup>(2)</sup>	110	7.8	660	220	440	440	215	185	150	4.3	4.4	904.250110.135B
250 <sup>(2)</sup>	125	7.8	660	220	440	440	205	175	140	4.9	4.75	904.250125.135B
250 <sup>(2)</sup>	160	7.8	660	220	440	440	180	130	50	6.2	4.85	904.250160.135B
250 <sup>(2)</sup>	200	7.8	660	220	440	440	150	50	90	6.2	5	904.250200.135B
315 <sup>(2)</sup>	110	9.8	840	280	560	560	305	260	235	4.3	8.6	904.315110.135B
315 <sup>(2)</sup>	125	9.8	840	280	560	560	290	250	220	4.9	9.15	904.315125.135B
315 <sup>(2)</sup>	160	9.8	840	280	560	560	270	205	200	6.2	9.15	904.315160.135B
315 <sup>(2)</sup>	200	9.8	840	280	560	560	240	125	175	6.2	9.45	904.315200.135B
315 <sup>(2)</sup>	250	9.8	840	280	560	560	205	130	140	7.8	9.25	904.315250.135B

(1) OD = outside diameter.

(2) Welded.

Table 9 135° reducing branch (continued)

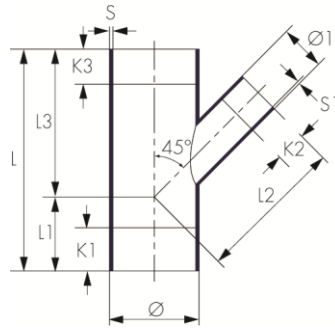

Table 10 Soil pipes — 88.5° swept branch

OD <sup>(1)</sup> (Ø) (mm)	OD <sup>(1)</sup> (Ø1) (mm)	Wall thickness (S) (mm)	Length (L) (mm)	Length (L1) (mm)	Length (L2) (mm)	Length (L3) (mm)	Length of straight (K1)	Length of straight (K2)	Length of straight (K3)	Wall thickness (S1) (mm)	Weight (kg)	Part no.
110	110	4.3	230	140	120	90	90	40	20	4.3	0.415	904.110.92B

(1) OD = outside diameter.

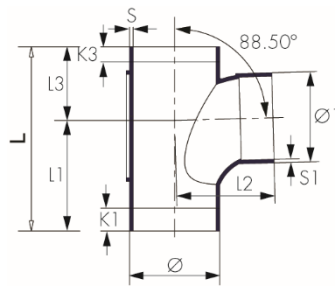

Table 11 135° double branch

OD <sup>(1)</sup> (Ø) (mm)	OD <sup>(1)</sup> (Ø1) (mm)	Wall thickness (S) (mm)	Length (L) (mm)	Length (L1) (mm)	Length (L2) (mm)	Length (L3) (mm)	Length of straight (K1)	Length of straight (K2)	Length of straight (K3)	Wall thickness (S1) (mm)	Weight (kg)	Part no.
110	40	4.3	270	90	180	180	95	30	15	3	0.435	906.11040.135B
110	50	4.3	270	90	180	180	95	30	15	3	0.455	906.11050.135B
110	110	4.3	270	90	180	180	50	15	15	4.3	0.63	906.110.135B
160 <sup>(2)</sup>	160	6.2	375	125	250	250	50	25	25	6.2	1.8	906.160.135B

(1) OD = outside diameter.

(2) Welded.

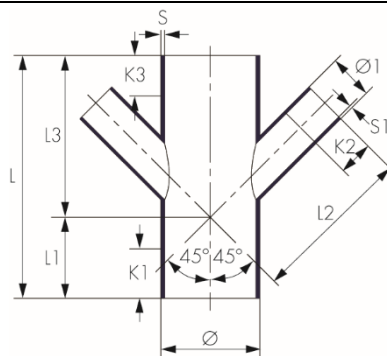
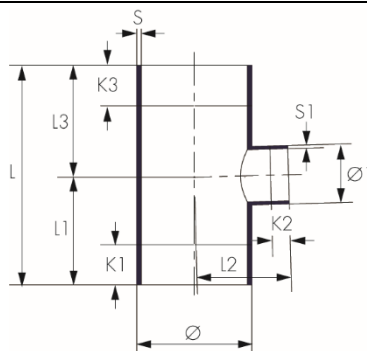

Table 12 88.5° equal branch

OD <sup>(1)</sup> (∅) (mm)	OD <sup>(1)</sup> (∅1) (mm)	Wall thickness (S) (mm)	Length (L) (mm)	Length (L1) (mm)	Length (L2) (mm)	Length (L3) (mm)	Length of straight (K1)	Length of straight (K2)	Length of straight (K3)	Wall thickness (S2) (mm)	Weight (kg)	Part no.
50	40	3	150	90	60	60	60	25	30	3	0.08	904.5040.90B
56	50	3	175	105	70	70	70	30	35	3	0.105	904.5650.90B
63	40	3	175	105	70	70	70	30	35	3	0.115	904.6340.90B
63	50	3	175	105	70	70	70	30	35	3	0.125	904.6350.90B
75	40	3	175	105	70	70	75	25	35	3	0.14	904.7540.90B
75	50	3	175	105	70	70	70	25	35	3	0.14	904.7550.90B
75	56	3	175	105	70	70	65	25	30	3	0.14	904.7556.90B
75	63	3	175	105	70	70	60	25	25	3	0.145	904.7563.90B
90	40	3.5	200	120	80	80	85	25	45	3	0.205	904.9040.90B
90	50	3.5	200	120	80	80	85	25	45	3	0.41	904.9050.90B
90	56	3.5	200	120	80	80	85	25	35	3	0.41	904.9056.90B
90	63	3.5	200	120	80	80	75	25	35	3	0.41	904.9063.90B
90	75	3.5	200	120	80	80	70	25	30	3	0.43	904.9075.90B
110	40	4.3	225	135	90	90	100	25	60	3	0.345	904.11040.90B
110	50	4.3	225	135	90	90	95	25	50	3	0.345	904.11050.90B
110	56	4.3	225	135	90	90	90	25	45	3	0.345	904.11056.90B
110	63	4.3	225	135	90	90	95	25	35	3	0.34	904.11063.90B
110	75	4.3	225	135	90	90	85	25	35	3	0.345	904.11075.90B
110	90	4.3	225	135	90	90	75	25	30	3.5	0.36	904.11090.90B
125	110	4.9	250	150	100	100	80	20	30	4.3	0.49	904.125110.90B
160	110	6.2	350	210	140	140	135	45	60	4.3	1.12	904.160110.90B
160	125	6.2	350	210	140	140	125	45	50	4.9	1.145	904.160125.90B
200 <sup>(2)</sup>	110	6.2	360	180	180	180	70	60	70	4.3	1.51	904.200110.90B
200 <sup>(2)</sup>	125	6.2	360	180	180	180	65	60	65	4.9	1.46	904.200125.90B
200 <sup>(2)</sup>	160	6.2	360	180	180	180	45	50	45	6.2	1.6	904.200160.90B
250 <sup>(2)</sup>	110	7.8	440	220	220	220	110	75	110	4.3	2.715	904.250110.90B
250 <sup>(2)</sup>	125	7.8	440	220	220	220	105	75	105	4.9	2.42	904.250125.90B
250 <sup>(2)</sup>	160	7.8	440	220	220	220	85	65	85	6.2	2.8	904.250160.90B
250 <sup>(2)</sup>	200	7.8	440	220	220	220	65	60	65	6.2	2.82	904.250200.90B
315 <sup>(2)</sup>	110	9.8	560	280	280	280	170	100	170	4.3	5.315	904.315110.90B
315 <sup>(2)</sup>	125	9.8	560	280	280	280	165	100	165	4.9	5.42	904.315125.90B
315 <sup>(2)</sup>	160	9.8	560	280	280	280	145	90	145	6.2	5.37	904.315160.90B
315 <sup>(2)</sup>	200	9.8	560	280	280	280	120	65	120	6.2	5.57	904.315200.90B
315 <sup>(2)</sup>	250	9.8	560	280	280	280	95	65	95	7.8	5.62	904.315250.90B

(1) OD = outside diameter.

(2) Welded.



**Table 13 Corner boss branch**

OD <sup>(1)</sup> ( $\varnothing$ ) (mm)	OD <sup>(1)</sup> ( $\varnothing$ 1) (mm)	Wall thickness (S) (mm)	Length (L) (mm)	Length (L1) (mm)	Length (L2) (mm)	Length (L3) (mm)	Length of straight (K1)	Length of straight (K2)	Length of straight (K3)	Wall thickness (S1) (mm)	Weight (kg)	Part no.
110	56	4.3	338	240	90	97	73	37	27	3	0.71	906.11090.12B

(1) OD = outside diameter.

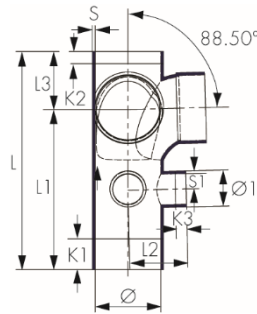

**Table 14 Corner branch**

OD <sup>(1)</sup> ( $\varnothing$ ) (mm)	Wall thickness (S) (mm)	Length (L) (mm)	Length (L1) (mm)	Length (L2) (mm)	Length (L3) (mm)	Length of straight (K1)	Length of straight (K2)	Weight (kg)	Part no.
110	4.4	231	134	120	97	43	37	0.479	906.11090.92B

(1) OD = outside diameter.

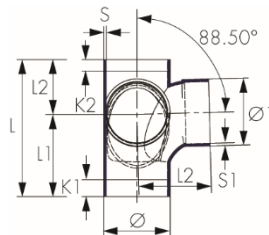

**Table 15 3-way branch**

OD <sup>(1)</sup> ( $\varnothing$ ) (mm)	Wall thickness (S) (mm)	Length (L) (mm)	Length (L1) (mm)	Length (L2) (mm)	Length (L3) (mm)	Length of straight (K1)	Length of straight (K2)	Weight (kg)	Part no.
110	4.4	231	134	120	97	43	37	0.579	906.11093.92B

(1) OD = outside diameter.

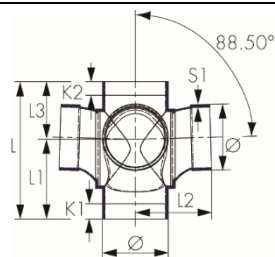

**Table 16 4-way branch**

OD <sup>(1)</sup> (∅) (mm)	OD <sup>(1)</sup> (∅1) (mm)	Wall thickness (S) (mm)	Length (L) (mm)	Length (L1) (mm)	Length (L2) (mm)	Length (L3) (mm)	Length of straight (K1) (mm)	Length of straight (K2) (mm)	Length of straight (K3) (mm)	Wall thickness (S1) (mm)	Weight (kg)	Part no.
110	56	4.3	257	177	90	79	133	37	37	3	0.483	920.110.56B
160	56	6.2	160	80	115	80	20	20	0	3	0.566	920.160.56B

(1) OD = outside diameter.

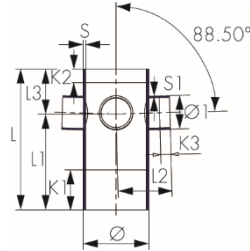

**Table 17 Single boss pipe**

OD <sup>(1)</sup> (∅) (mm)	OD <sup>(1)</sup> (∅1) (mm)	Wall thickness (S) (mm)	Length (L) (mm)	Length (L1) (mm)	Length (L2) (mm)	Length (L3) (mm)	Length of straight (K1) (mm)	Length of straight (K2) (mm)	Length of straight (K3) (mm)	Wall thickness (S1) (mm)	Weight (kg)	Part no.
110	56	4.3	338	240	90	97	73	37	27	3	0.575	904.11090.12B

(1) OD = outside diameter.

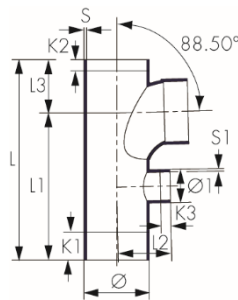

**Table 18 Double branch**

OD <sup>(1)</sup> (∅) (mm)	OD <sup>(1)</sup> (∅1) (mm)	Wall thickness (S) (mm)	Length (L) (mm)	Length (L1) (mm)	Length (L2) (mm)	Length (L3) (mm)	Length of straight (K1) (mm)	Length of straight (K2) (mm)	Weight (kg)	Part no.
110	110	4.3	231	134	120	97	43	37	0.553	906.110.92B

(1) OD = outside diameter.

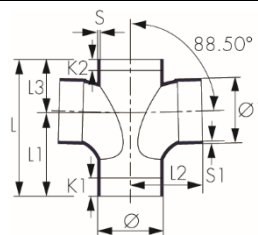

**Table 19 180° Double branch ball fitting**

OD <sup>(1)</sup> (Ø) (mm)	OD <sup>(1)</sup> (Ø1) (mm)	Wall thickness (S) (mm)	External diameter (DE)	Length (L1) (mm)	Length (L2) (mm)	Length (L3) (mm)	Height (H) (mm)	Length of straight (K1)	Length of straight (K2)	Length of straight (K3)	Wall thickness (S1) (mm)	Weight (kg)	Part no.
110	50	4.3	170	105	120	105	220	15	15	15	3	0.44	916.11050.180B
110	56	4.3	170	105	120	105	220	15	15	15	3	0.45	916.11056.180B
110	75	4.3	170	105	120	105	220	15	15	15	3	0.43	916.11075.180B
110	90	4.3	170	105	120	105	220	15	15	15	3.5	0.47	916.11090.180B
110	110	4.3	170	105	120	105	220	15	15	15	4.3	0.48	916.110.180B
125	50	4.9	190	110	125	110	220	15	15	15	3	0.495	916.12550.180B
125	56	4.9	190	110	125	110	220	15	15	15	3	0.5	916.12556.180B
125	75	4.9	190	110	125	110	220	15	15	15	3	0.555	916.12575.180B
125	90	4.9	190	110	125	110	220	15	15	15	3.5	0.555	916.12590.180B
125	110	4.9	190	110	125	110	220	15	25	15	4.3	0.565	916.125110.180B
125	125	4.9	190	110	125	110	220	15	25	15	4.9	0.625	916.125.180B

(1) OD = outside diameter.

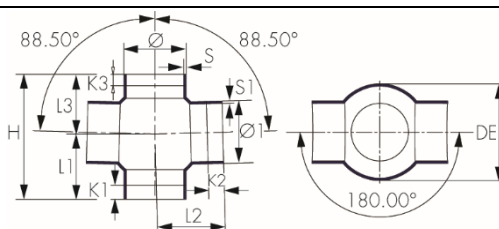

**Table 20 90° Double branch ball fitting**

OD <sup>(1)</sup> (Ø) (mm)	OD <sup>(1)</sup> (Ø1) (mm)	Wall thickness (S) (mm)	External diameter (DE)	Length (L1) (mm)	Length (L2) (mm)	Length (L3) (mm)	Height (H) (mm)	Length of straight (K1)	Length of straight (K2)	Length of straight (K3)	Wall thickness (S1) (mm)	Weight (kg)	Part no.
110	50	4.3	170	105	120	105	220	15	15	15	3	0.45	916.11050.90B
110	56	4.3	170	105	120	105	220	15	15	15	3	0.425	916.11056.90B
110	75	4.3	170	105	120	105	220	15	15	15	3	0.5	916.11075.90B
110	90	4.3	170	105	120	105	220	15	15	15	3.5	0.465	916.11090.90B
110	110	4.3	170	105	120	105	220	15	15	15	4.3	0.505	916.110.90B
125	50	4.9	190	110	125	110	220	15	15	15	3	0.5	916.12550.90B
125	56	4.9	190	110	125	110	220	15	15	15	3	0.5	916.12556.90B
125	75	4.9	190	110	125	110	220	15	15	15	3	0.53	916.12575.90B
125	90	4.9	190	110	125	110	220	15	15	15	3.5	0.54	916.12590.90B
125	110	4.9	190	110	125	110	220	15	25	15	4.3	0.605	916.125110.90B
125	125	4.9	190	110	125	110	220	15	25	15	4.9	0.62	916.125.90B

(1) OD = outside diameter.

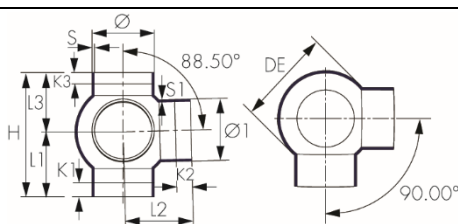

**Table 21 135° Double branch ball fitting**

OD <sup>(1)</sup> (Ø) (mm)	OD <sup>(1)</sup> (Ø1) (mm)	Wall thickness (S) (mm)	External diameter (DE)	Length (L1) (mm)	Length (L2) (mm)	Length (L3) (mm)	Height (H) (mm)	Length of straight (K1)	Length of straight (K2)	Length of straight (K3)	Wall thickness (S1) (mm)	Weight (kg)	Part no.
110	50	4.3	170	105	120	105	220	15	15	15	3	0.44	916.11050.135B
110	56	4.3	170	105	120	105	220	15	15	15	3	0.445	916.11056.135B
110	75	4.3	170	105	120	105	220	15	15	15	3	0.455	916.11075.135B
110	90	4.3	170	105	120	105	220	15	15	15	3.5	0.47	916.11090.135B
110	110	4.3	170	105	120	105	220	15	25	15	4.3	0.5	916.110.135B
125	50	4.9	190	110	125	110	220	15	15	15	3	0.49	916.12550.135B
125	56	4.9	190	110	125	110	220	15	15	15	3	0.555	916.12556.135B
125	75	4.9	190	110	125	110	220	15	15	15	3	0.565	916.12575.135B
125	90	4.9	190	110	125	110	220	15	15	15	3.5	0.575	916.12590.135B
125	110	4.9	190	110	125	110	220	15	25	15	4.3	0.6	916.125110.135B
125	125	4.9	190	110	125	110	220	15	25	15	4.9	0.74	916.125.135B

(1) OD = outside diameter.

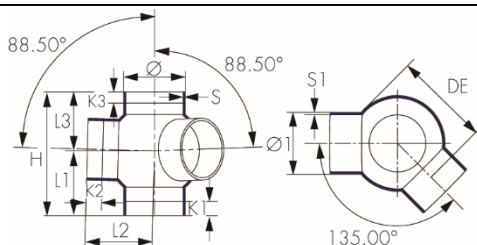

**Table 22 90° 3-way branch ball fitting**

OD <sup>(1)</sup> (Ø) (mm)	OD <sup>(1)</sup> (Ø1) (mm)	Wall thickness (S) (mm)	External diameter (DE)	Length (L1) (mm)	Length (L2) (mm)	Length (L3) (mm)	Height (H) (mm)	Length of straight (K1)	Length of straight (K2)	Length of straight (K3)	Wall thickness (S1) (mm)	Weight (kg)	Part no.
110	50	4.3	170	105	120	105	220	15	15	15	3	0.32	916.11050.903B
110	56	4.3	170	105	120	105	220	15	15	15	3	0.47	916.11056.903B
110	75	4.3	170	105	120	105	220	15	15	15	3	0.46	916.11075.903B
110	90	4.3	170	105	120	105	220	15	15	15	3.5	0.51	916.11090.903B
110	110	4.3	170	105	120	105	220	15	15	15	4.3	0.545	916.110.903B
125	50	4.9	190	110	125	110	220	15	15	15	3	0.57	916.12550.903B
125	56	4.9	190	110	125	110	220	15	15	15	3	0.515	916.12556.903B
125	75	4.9	190	110	125	110	220	15	15	15	3	0.515	916.12575.903B
125	90	4.9	190	110	125	110	220	15	15	15	3.5	0.525	916.12590.903B
125	110	4.9	190	110	125	110	220	15	25	15	4.3	0.595	916.125110.903B
125	125	4.9	190	110	125	110	220	15	25	15	4.9	0.67	916.125.903B

(1) OD = outside diameter.

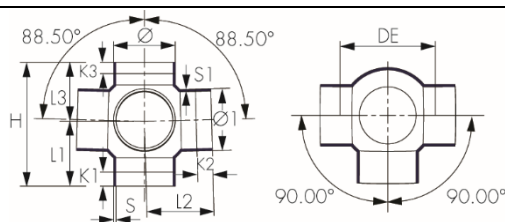

**Table 23 135° 3-way branch ball fitting**

OD <sup>(1)</sup> (Ø) (mm)	OD <sup>(1)</sup> (Ø1) (mm)	Wall thickness (S) (mm)	External diameter (DE)	Length (L1) (mm)	Length (L2) (mm)	Length (L3) (mm)	Height (H) (mm)	Length of straight (K1)	Length of straight (K2)	Length of straight (K3)	Wall thickness (S1) (mm)	Weight (kg)	Part no.
110	50	4.3	170	105	120	105	220	15	15	15	3	0.465	916.11050.1353B
110	56	4.3	170	105	120	105	220	15	15	15	3	0.455	916.11056.1353B
110	75	4.3	170	105	120	105	220	15	15	15	3	0.44	916.11075.1353B
110	90	4.3	170	105	120	105	220	15	15	15	3.5	0.45	916.11090.1353B
110	110	4.3	170	105	120	105	220	15	15	15	4.3	0.54	916.110.1353B
125	50	4.9	190	110	125	110	220	15	15	15	3	0.63	916.12550.1353B
125	56	4.9	190	110	125	110	220	15	15	15	3	0.515	916.12556.1353B
125	75	4.9	190	110	125	110	220	15	15	15	3	0.62	916.12575.1353B
125	90	4.9	190	110	125	110	220	15	15	15	3.5	0.63	916.12590.1353B
125	110	4.9	190	110	125	110	220	15	25	15	4.3	0.62	916.125110.1353B
125	125	4.9	190	110	125	110	220	15	25	15	4.9	0.67	916.125.1353B

(1) OD = outside diameter.

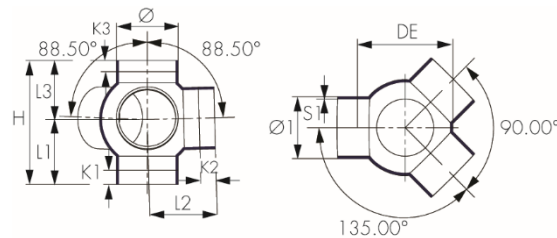

**Table 24 90° 4-way branch ball fitting**

OD <sup>(1)</sup> (Ø) (mm)	OD <sup>(1)</sup> (Ø1) (mm)	Wall thickness (S) (mm)	External diameter (DE)	Length (L1) (mm)	Length (L2) (mm)	Length (L3) (mm)	Height (H) (mm)	Length of straight (K1)	Length of straight (K2)	Length of straight (K3)	Wall thickness (S1) (mm)	Weight (kg)	Part no.
110	50	4.3	170	105	120	105	220	15	15	15	3	0.48	916.11050.904B
110	56	4.3	170	105	120	105	220	15	15	15	3	0.48	916.11056.904B
110	75	4.3	170	105	120	105	220	15	15	15	3	0.475	916.11075.904B
110	90	4.3	170	105	120	105	220	15	15	15	3.5	0.535	916.11090.904B
110	110	4.3	170	105	120	105	220	15	15	15	4.3	0.575	916.110.904B
125	110	4.9	190	105	125	105	220	15	25	15	4.3	0.69	916.125110.904B
125	50	4.9	190	105	125	105	220	15	15	15	3	0.53	916.12550.904B
125	56	4.9	190	105	125	105	220	15	15	15	3	0.485	916.12556.904B
125	75	4.9	190	105	125	105	220	15	15	15	3	0.425	916.12575.904B
125	90	4.9	190	105	125	105	220	15	15	15	3.5	0.68	916.12590.904B
125	125	4.9	190	105	125	105	220	15	25	15	4.3	0.74	916.125.904B

(1) OD = outside diameter.

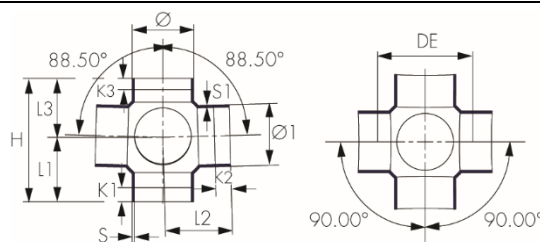
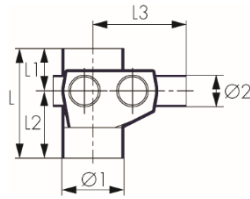



**Table 25 Low level manifold**

OD <sup>(1)</sup> (Ø1) (mm)	OD <sup>(1)</sup> (Ø2) (mm)	Length (L) (mm)	Length (L1) (mm)	Length (L2) (mm)	Length (L3) (mm)	Weight (kg)	Part no.
110	56	202	83	119	163	0.503	919.110.56B
160	56	222	78	144	157	0.984	919.160.56B

(1) OD = outside diameter.



**Table 26 Short ring seal socket**

OD <sup>(1)</sup> (Ø) (mm)	Wall thickness (S) (mm)	External diameter (DE)	Length (L) (mm)	Length (L1) (mm)	Weight (kg)	Part no.
90	3.5	108	42	31.5	0.07	909.90B
110	4.3	130	42	31.5	0.115	909.110B

(1) OD = outside diameter.

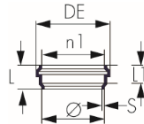

**Table 27 Ring seal socket**

OD <sup>(1)</sup> (Ø/Ø1) (mm)	Wall thickness (S) (mm)	External diameter (DE)	Length (L) (mm)	Length (L1) (mm)	Weight (kg)	Part no.
40	3	56.5	65	13	0.04	927.40B
50	3	66.5	65	13	0.05	927.50B
56	3	72.5	65	13	0.05	927.56B
63	3	79	65	11	0.065	927.63B
75	3	92	90	17	0.11	927.75B
90	3.5	108	90	17	0.15	927.90B
110	4.3	130	95	17	0.22	927.110B
125	4.9	149	95	15	0.23	927.125B
160	6.2	188	130	30	0.53	927.160B
200	6.2	225	170	18	1.075	927.200B
250	7.8	278	170	22	1.37	927.250B
315	9.8	350	180	22	1.97	927.315B

(1) OD = outside diameter.

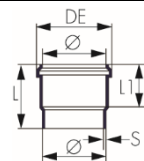

**Table 28 Expansion joint**

OD <sup>(1)</sup> ( $\emptyset$ ) (mm)	Wall thickness (S) (mm)	External diameter (DE)	Length (L) (mm)	Length (L1) (mm)	Length of straight (K)	Weight (kg)	Part no.
40	3	73	235	60	40	0.16	911.40B
50	3	81	235	56	40	0.2	911.50B
56	3	90	235	50	40	0.22	911.56B
63	3	96	235	56	40	0.25	911.63B
75	3	109	235	56	40	0.3	911.75B
90	3.5	117	235	54	40	0.335	911.90B
110	4.3	140	255	46	20	0.5	911.110B
125	4.9	154	235	53	40	0.625	911.125B
160	6.2	192	260	72	40	1.01	911.160B
200	6.2	228	350	80	40	1.85	911.200B
250	7.8	280	440	183	100	3.38	911.250B
315	9.8	350	480	183	100	6.1	911.315B

(1) OD = outside diameter.

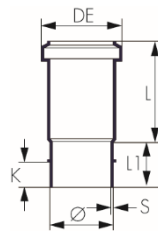
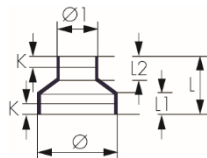

Table 29 Concentric reducer

OD <sup>(1)</sup> (Ø) (mm)	OD <sup>(1)</sup> (Ø1) (mm)	Wall thickness (S) (mm)	Length (L) (mm)	Length (L1) (mm)	Length (L2) (mm)	Length of straight (K)	Wall thickness (S1) (mm)	Weight (kg)	Part no.
50	40	3	80	30	30	15	3	0.04	924.5040B
56	40	3	80	30	30	15	3	0.04	924.5640B
56	50	3	80	30	30	15	3	0.04	924.5650B
63	40	3	80	30	30	15	3	0.04	924.6340B
63	50	3	80	30	30	15	3	0.05	924.6350B
63	56	3	80	30	30	15	3	0.045	924.6356B
75	40	3	80	30	30	15	3	0.045	924.7540B
75	50	3	80	30	30	15	3	0.05	924.7550B
75	56	3	80	30	30	15	3	0.06	924.7556B
75	63	3	80	30	30	15	3	0.06	924.7563B
90	40	3.5	80	30	30	15	3	0.085	924.9040B
90	50	3.5	80	30	30	15	3	0.065	924.9050B
90	56	3.5	80	30	30	15	3	0.07	924.9056B
90	63	3.5	80	30	30	15	3	0.09	924.9063B
90	75	3.5	80	30	30	15	3	0.095	924.9075B
110	40	4.3	80	30	30	15	3	0.09	924.11040B
110	50	4.3	80	30	30	15	3	0.115	924.11050B
110	56	4.3	80	30	30	15	3	0.095	924.11056B
110	63	4.3	80	30	30	15	3	0.105	924.11063B
110	75	4.3	80	30	30	15	3	0.125	924.11075B
110	90	4.3	80	30	30	15	3.5	0.125	924.11090B
125	50	4.9	80	30	30	15	3	0.125	924.12550B
125	56	4.9	80	30	30	15	3	0.125	924.12556B
125	63	4.9	80	30	30	15	3	0.125	924.12563B
125	75	4.9	80	30	30	15	3	0.135	924.12575B
125	90	4.9	80	30	30	15	3.5	0.255	924.12590B
125	110	4.9	80	30	40	20	4.3	0.325	924.125110B
160	110	6.2	115	30	30	15	4.3	0.255	924.160110B
160	125	6.2	80	39	30	15	4.9	0.237	924.160125B
200	160	9.2	180	60	60	20	6.2	0.325	924.200160B

(1) OD = outside diameter.



**Table 30 Compression joint**

OD <sup>(1)</sup> (∅) (mm)	Wall thickness (S) (mm)	External diameter (DE)	Length (L) (mm)	Length (L1) (mm)	Length (L2) (mm)	Length (L3) (mm)	Weight (kg)	Part no.
40	3	60	74	30	34	66	0.075	912.40B
50	3	70	76	30	33	66	0.08	912.50B
56	3	80	46	30	34	66	0.12	912.56B
63	3	85	79	30	43	66	0.13	912.63B
63	3	85	79	30	43	66	0.13	912.63B
75	3	109	106	30	45	87	0.25	912.75B
90	3.5	128	86	30	46	88	0.34	912.90B
110	4.3	144	113	30	65	89	0.47	912.110B

(1) OD = outside diameter.

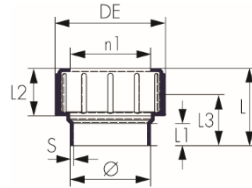

**Table 31 Stop end**

OD <sup>(1)</sup> (∅) (mm)	Wall thickness (S) (mm)	External diameter (DE)	Length (L) (mm)	Length (L1) (mm)	Length (L2) (mm)	Length (L3) (mm)	Weight (kg)	Part no.
40	3	60	75	30	34	66	0.075	936.40B
50	3	70	75	30	33	66	0.08	936.50B
56	3	80	77	30	34	66	0.12	936.56B
63	3	85	76	30	43	66	0.135	936.63B
75	3	109	103	30	45	87	0.28	936.75B
90	3.5	128	103	30	46	88	0.355	936.90B
110	4.3	144	106	30	65	89	0.5	936.110B

(1) OD = outside diameter.

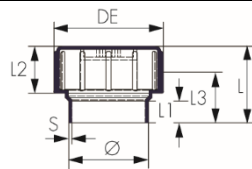

**Table 32 Weld-on cap 40-125 mm**

OD <sup>(1)</sup> (∅) (mm)	Wall thickness (S) (mm)	Length (L) (mm)	Weight (kg)	Part no.
40	3	10	0.01	930.40B
50	3	10	0.01	930.50B
56	3	10	0.01	930.56B
63	3	10	0.015	930.63B
75	3	10	0.02	930.75B
90	3.5	10	0.03	930.90B
110	4.3	10	0.05	930.110B
125	4.9	10	0.07	930.125B

(1) OD = outside diameter.

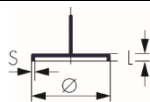

**Table 33 Weld on cap 160-315 mm**

OD <sup>(1)</sup> (∅) (mm)	Wall thickness (S) (mm)	Length (L) (mm)	Weight (kg)	Part no.
160	6.2	72	0.31	930.160B
200	6.2	110	0.56	930.200B
250	7.8	93	0.75	930.250B
315	9.2	117	1.42	930.315B

(1) OD = outside diameter.

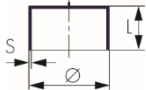

**Table 34 Anchor pipes**

OD <sup>(1)</sup> (∅) (mm)	Wall thickness (S) (mm)	External diameter (DE)	Length (L) (mm)	Length (L1) (mm)	Wall thickness (S1) (mm)	Weight (kg)	Part no.
50	3	57	68	32	4	0.03	970.50B
56	3	64	68	32	4	0.035	970.56B
63	3	71	72	34	4	0.045	970.63B
75	3	84	83	39.5	5	0.06	970.75B
90	3.5	100	100	47.5	5	0.1	970.90B
110	4.3	120	112	53.5	6	0.165	970.110B

(1) OD = outside diameter.

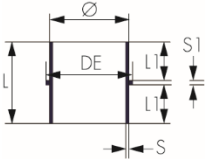

**Table 35 Access pipe**

OD <sup>(1)</sup> (∅) (mm)	Wall thickness (S) (mm)	External diameter (DE)	Length (L) (mm)	Length (L1) (mm)	Length (L2) (mm)	Height (H) (mm)	Length of straight (K1)	Length of straight (K2)	Weight (kg)	Part no.
50	3	70	150	90	60	75	55	25	0.13	938.50.90B
56	3	85	175	105	70	84	65	30	0.195	938.56.90B
63	3	82	175	100	75	80	60	25	0.175	938.63.90B
75	3	117	175	105	70	117	55	25	0.365	938.75.90B
90	3.5	123	200	120	80	125	65	25	0.52	938.90.90B
110	4.3	146	240	140	100	94	65	20	0.62	938.110.90B
125	4.9	146	250	150	100	124	70	20	0.77	938.125.90B
160	6.2	146	350	210	140	145	105	30	1.355	938.160.90B
200	6.2	146	360	180	180	165	180	25	1.71	938.200.90B
250	7.8	146	440	220	220	190	220	40	3.075	938.250.90B
315	9.8	146	560	280	280	225	280	70	5.5	938.315.90B

(1) OD = outside diameter.

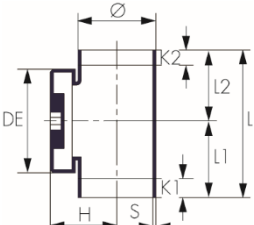

**Table 36 45° Access pipe**

OD <sup>(1)</sup> (∅) (mm)	OD(1) (∅1) (mm)	Wall thickness (S) (mm)	External diameter (DE)	Length (L) (mm)	Length (L1) (mm)	Length (L2) (mm)	Height (H) (mm)	Length of straight (K1)	Wall thickness (S1) (mm)	Weight (kg)	Part no.
110	110	4.3	150	270	90	180	220	55	4.3	0.84	938.110.135B
125	110	4.9	150	300	100	200	230	70	4.3	1.24	938.125.135B
160	110	6.2	150	375	125	275	280	110	4.3	1.76	938.160.135B

(1) OD = outside diameter.

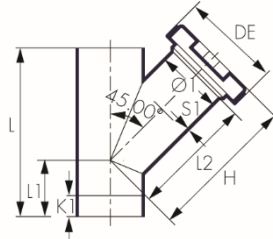

**Table 37 Electrofusion coupling**

OD <sup>(1)</sup> (∅) (mm)	External diameter (DE)	Length (L) (mm)	Height (H) (mm)	Height (H1) (mm)	Weight (kg)	Part no.
40	52	64	68	3	0.055	910.40B
50	63	60	80	3	0.07	910.50B
56	70	60	86	3	0.085	910.56B
63	77	60	92	3	0.08	910.63B
75	90	60	105	3	0.105	910.75B
90	106	60	121	3	0.135	910.90B
110	126	60	143	3	0.165	910.110B
125	142	60	158	3	0.21	910.125B
160	178	60	194	3	0.26	910.160B
200	233	153	248	3	1.705	910.200B
250	285	153	300	3	2.135	910.250B
315	350	153	365	3	2.61	910.315B

(1) OD = outside diameter.

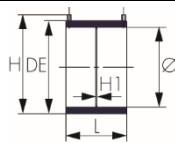

**Table 38 Sliding connector**

OD <sup>(1)</sup> (∅) (mm)	Wall thickness (S) (mm)	External diameter (DE)	Length (L) (mm)	Weight (kg)	Part no.
110	4.3	130	210	1	911S.110B
160	6.7	185	230	1.225	911S.160B
200	6.7	226	270	1.445	911S.200B
250	8.3	284	300	2.91	911S.250B
315	10.4	354	320	5.1	911S.315B

(1) OD = outside diameter

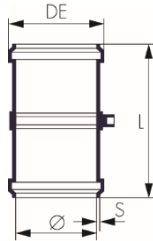

**Table 39 Ring seal socket**

OD <sup>(1)</sup> (∅) (mm)	Wall thickness (S) (mm)	External diameter (DE)	Length (L) (mm)	Height (H) (mm)	Weight (kg)	Part no.
110	4.3	130	160	11	1	910P.110B
160	6.7	185	230	6	1.24	910P.160B
200	6.7	226	270	6	1.815	910P.200B
250	8.3	284	300	7	5.14	910P.250B
315	10.4	354	320	9	7.33	910P.315B

(1) OD = outside diameter

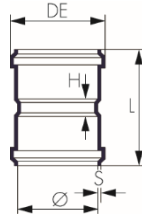
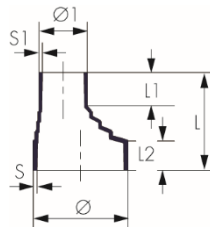

Table 40 Eccentric reducer

OD <sup>(1)</sup> (∅) (mm)	OD <sup>(1)</sup> (∅1) (mm)	Wall thickness (S) (mm)	Length (L) (mm)	Length (L1) (mm)	Length (L2) (mm)	Wall thickness (S1) (mm)	Weight (kg)	Part no.
50	40	3	80	35	35	3	0.035	923.5040B
56	40	3	80	37	35	3	0.037	923.5640B
56	50	3	80	37	35	3	0.04	923.5650B
63	40	3	80	37	35	3	0.04	923.6340B
63	50	3	80	37	35	3	0.04	923.6350B
63	56	3	80	40	35	3	0.045	923.6356B
75	40	3	80	37	35	3	0.055	923.7540B
75	50	3	80	37	35	3	0.05	923.7550B
75	56	3	80	37	35	3	0.05	923.7556B
75	63	3	80	35	35	3	0.055	923.7563B
90	40	3.5	80	37	35	3	0.065	923.9040B
90	50	3.5	80	37	35	3	0.065	923.9050B
90	56	3.5	80	37	35	3	0.075	923.9056B
90	63	3.5	80	37	35	3	0.07	923.9063B
90	75	3.5	80	37	35	3	0.095	923.9075B
110	40	4.3	80	37	35	3	0.095	923.11040B
110	50	4.3	80	37	35	3	0.1	923.11050B
110	56	4.3	80	37	35	3	0.1	923.11056B
110	63	4.3	80	37	35	3	0.105	923.110.63B
110	75	4.3	80	37	35	3	0.105	923.11075B
110	90	4.3	80	37	35	3.5	0.14	923.11090B
125	50	4.9	80	37	35	3	0.13	923.12550B
125	56	4.9	80	37	35	3	0.125	923.12556B
125	63	4.9	80	37	35	3	0.125	923.12563B
125	75	4.9	80	37	35	3	0.13	923.12575B
125	90	4.9	80	37	35	3.5	0.13	923.12590B
125	110	4.9	80	37	35	4.3	0.135	923.125110B
160	110	6.2	80	37	35	4.3	0.23	923.160110B
160	125	6.2	80	37	35	4.9	0.22	923.160125B

(1) OD = outside diameter

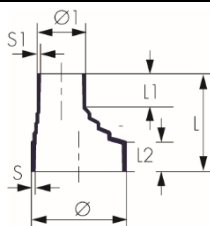



**Table 41 Long eccentric reducer**

OD <sup>(1)</sup> (Ø) (mm)	OD <sup>(1)</sup> (Ø1) (mm)	Wall thickness (S) (mm)	Length (L) (mm)	Length (L1) (mm)	Length (L2) (mm)	Length of straight (K1)	Length of straight (K2)	Wall thickness (S1) (mm)	Weight (kg)	Part no.
160	110	6.2	215	35	37	20	20	4.3	0.43	923.160110LB
160	125	6.2	140	45	40	20	20	4.9	0.33	923.160125LB
200	110	6.2	285	80	40	50	10	4.3	0.94	923.200110LB
200	125	6.2	285	80	40	50	10	4.9	0.91	923.200125LB
200	160	6.2	210	80	37	50	10	6.2	0.72	923.200160LB
250	200	7.8	405	160	140	100	100	6.2	1.965	923.250200LB
315	200	9.8	540	160	140	100	100	6.2	3.49	923.315200LB
315	250	9.8	450	160	150	100	100	7.8	3.295	923.315250LB

(1) OD = outside diameter.



**Table 42 Ventilation branch**

OD <sup>(1)</sup> (Ø) (mm)	OD <sup>(1)</sup> (Ø1) (mm)	OD <sup>(1)</sup> (Ø2) (mm)	OD <sup>(1)</sup> (Ø3) (mm)	OD <sup>(1)</sup> (Ø4) (mm)	OD <sup>(1)</sup> (Ø5) (mm)	OD <sup>(1)</sup> (Ø6) (mm)	Length (L) (mm)	Length (L1) (mm)	Length (L2) (mm)	Length (L3) (mm)	Length (L4) (mm)	Height (H) (mm)	Height (H1) (mm)	Height (H2) (mm)	Height (H3) (mm)	Weight (kg)	Part no.
110	110 max	110 max	110 max	75 max	75 max	75 max	275	90	130	55	188	700	230	170	300	2.57	908.110B
160	110 max	110 max	110 max	75 max	75 max	75 max	310	90	160	60	190	1010	460	170	380	5	908.160B

(1) OD = outside diameter.

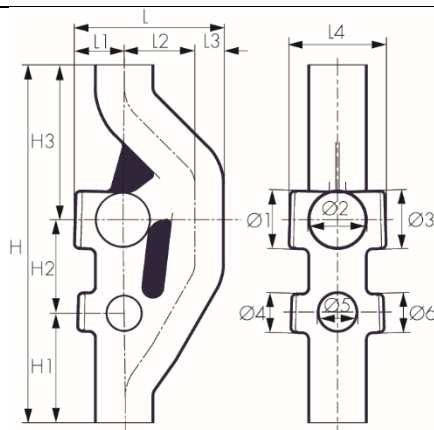

1.4 Six methods are available for joining the Terrain FUZE pipe and fittings<sup>(1)</sup> (see Figure 1):

- butt welding
- screw-threaded joint
- electrofusion coupling
- expansion socket
- ring seal socket
- flange joint.

(1) The Terrain FUZE Jointing Methods brochure gives full details of each method.

## 2 Manufacture

2.1 The system components are manufactured from HDPE through an extrusion or injection-moulding process. The processes comply with the recommendations of BS EN 1519-1 : 2000. All the components are black in colour and the pipes are produced in 3 and 5 m lengths.

2.2 As part of the assessment and ongoing surveillance of product quality, the BBA has:

- agreed with the manufacturer the quality control procedures and product testing to be undertaken
- assessed and agreed the quality control operated over batches of incoming materials
- monitored the production process and verified that it is in accordance with the documented process
- evaluated the process for management of nonconformities
- checked that equipment has been properly tested and calibrated
- undertaken to carry out the above measures on a regular basis through a surveillance process, to verify that the specifications and quality control operated by the manufacturer are being maintained.

2.3 The HDPE pipes are extruded from batch-mixed raw materials and cut to length, and the fittings are injection-moulded or welded extrusions.

2.4 Continuous quality control is exercised during manufacture to maintain quality. The checks include:

### Pipes

- appearance
- dimensional accuracy
- pressure
- melt-flow index
- heat reversion.

### Fittings

- appearance
- dimensional accuracy
- appearance and dimensional stability after heating to 60°C–110°C
- melt-flow index.

2.5 The management systems of Polypipe Ltd have been assessed and registered as meeting the requirements of BS EN ISO 9001 : 2015 by BSI (Certificate FM33774).

2.6 The system components are manufactured in the UK by Polypipe Ltd (and its suppliers, in Italy). They are marketed/distributed in the UK under the Terrain brand.

Figure 1 Terrain FUZE jointing methods

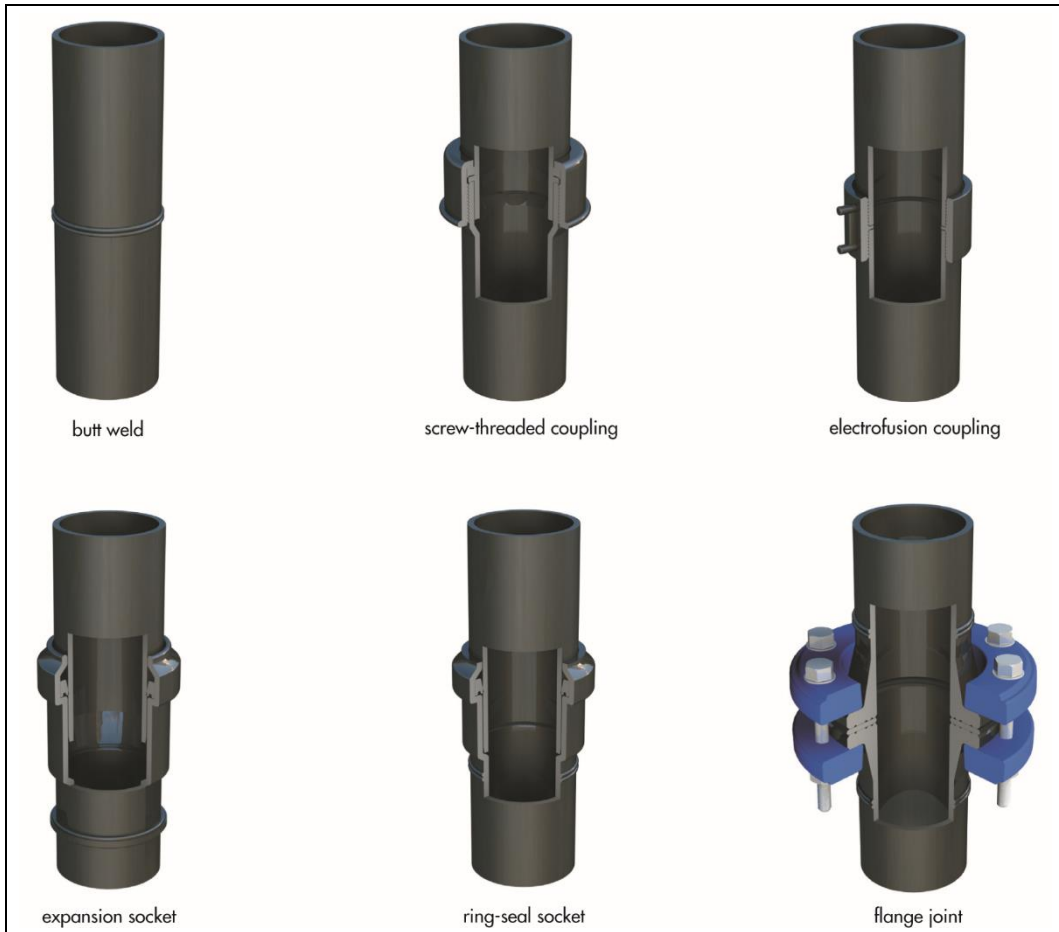

### 3 Delivery and site handling

3.1 The pipes are supplied in lightweight, reinforced brackets and should be stored on a flat surface in stacks not more than 1.7 m high, away from heat sources and out of direct sunlight, to avoid distortion.

3.2 The pipes are marked with:

- material HDPE
- outside diameter and wall thickness
- BS EN 1519-1 : 2000
- manufacturer's mark.

3.3 The fittings are supplied in boxes which are marked with the associated outside diameter and reference code.

## Assessment and Technical Investigations

The following is a summary of the assessment and technical investigations carried out on the Terrain FUZE Drainage System.

## Design Considerations

### 4 Use



4.1 The system is satisfactory for use in domestic, commercial and public buildings and in installations designed in accordance with BS EN 12056-2 : 2000 and BS EN 12056-3 : 2000 for the conveyance of surface water and domestic sewage as is permitted to be discharged into public sewers by the Public

Health Act 1936 (England and Wales), and surface water and sewage as is permitted and defined by the Sewerage (Scotland) Act 1968 and the Water and Sewerage Services (Northern Ireland) Order 2006.

4.2 The average linear expansion coefficient for the pipes is  $2 \times 10^{-4} \cdot ^\circ\text{C}^{-1}$ . Installations must be designed to accommodate or prevent the anticipated thermal movement in accordance with sections 4.3 to 4.7.

### Prevention of longitudinal thermal movement



4.3 Movement can be prevented by embedding the pipe (with electroweld sleeves or bushes) in concrete or by rigid fixings.

### Embedment



4.4 The adhesion between concrete and pipe is inadequate to prevent movement. When installed within concrete floors, the movement is prevented electroweld sleeves or bushes which protrude from the external surface of the pipe. These fittings must be used near each branch connection. Ring-seal sockets should not be embedded in concrete. The expansion and contraction forces created by the constraint of thermal movement must be accommodated by the concrete surround.

4.5 The forces exerted on pipe supports, anchors and the structure must be considered when this approach is used. Rigid fixings are not considered suitable for pipes over 160 mm in diameter. Guidance on the load exerted on fixings is available from the manufacturer.

### Accounting for length/longitudinal movement



4.6 Vertical and horizontal expansion can be catered for by the expansion socket. The product is designed to cope with the expansion equivalent to a 5 m run of pipe through a temperature change of  $80^\circ\text{C}$ . This product should be used in conjunction with rigid anchor fixings and sliding guide hangers. Sliding guide hangers are not provided as part of the system, but are available as proprietary products outside the scope of this Certificate.

4.7 Thermal movement can also be accommodated by the incorporation of a deflection leg within the design of the installation of the system. The maximum anticipated movement is determined, and the length of the required deflection leg appropriate to the predicted movement. Sliding supports allow the pipe expansion to occur between two fixed supports in the structure.

4.8 When using pipes in a low-pressure environment, designers should consider a maximum load of 15 m water column (1.5 bar) temperature of  $30^\circ\text{C}$  (10 years).

## 5 Practicability of installation

Installation of the pipes and fittings is achieved easily providing the procedures detailed in the Terrain FUZE Drainage brochure are strictly adhered to (see also section 14 of this Certificate).

## 6 Strength



6.1 The pipes and fittings will have adequate resistance to the types of loading associated with installation and normal service conditions.

6.2 The system should be protected from impacts, for example from heavy vehicles such as fork-lift trucks used on commercial premises.

## 7 Performance of joints



7.1 The joints will not be adversely affected by thermal movement provided the correct provision is made.

7.2 The joints will remain watertight under conditions of pipeline movement in excess of those expected to occur in normal good drainage practice.

## 8 Flow characteristics



8.1 A system incorporating Terrain FUZE pipes and fittings will have satisfactory flow characteristics. Primary ventilated stack systems to BS EN 12056-2 : 2000, clause 4.3.1 and Table 1, are restricted in accordance with clause 6.5.1 and Table 11. For flow capacity calculations, ball fittings should be considered as having square entries.

8.2 Use of ventilation branches in a stack allows the design flow rate of a 110 mm primary ventilated stack to be increased to 8.7 l·s<sup>-1</sup> maximum, and the 160 mm diameter to 18.1 l·s<sup>-1</sup> maximum, thus avoiding the need for additional ventilation (see Table 43). The stack design must be in accordance with the Certificate holder's guidelines (see Figure 2). A ventilation branch fitting must be installed at each floor above the ground floor, even if appliances are not connected. The ground pipe must be 160 mm in diameter and a pressure relief line must be installed at the bend at the bottom of the stack.

Table 43 Maximum flow rates of waste in the stacks with ventilation branches

Stack diameter		Total flow dischargeable of the stack ( $\sum DU$ ) (l·s <sup>-1</sup> )	Maximum project flow in the stack ( $Q_{ww}$ ) (l·s <sup>-1</sup> )	Maximum number of connectable equivalent apartments
DN (mm)	DE (mm)			
100	110	303	8.7	45
150	160	1310	18.1	195

## 9 Resistance to chemicals



The system will be unaffected by the types and quantities of chemicals likely to be found in the effluents defined in section 4.1.

## 10 Resistance to elevated temperatures



The system has adequate resistance to the temperatures likely to occur in the effluents defined in section 4.1.

Figure 2 Waste system with ventilation branches

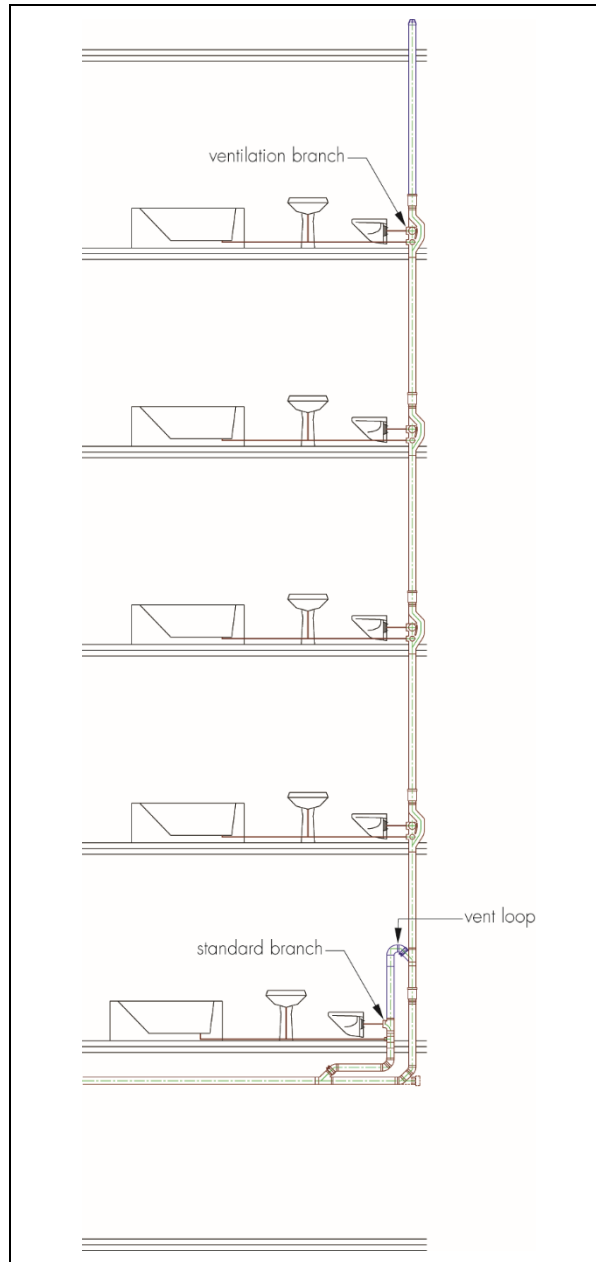

## 11 Behaviour in relation to fire

11.1 In common with other plastics materials, the pipes and fittings are combustible and in a fire may ignite and burn. The pipes and fittings are HDPE and their burning will not result in the release of toxic gases. However, consideration should be given to the need for protective, fire-resistant ducting when assessing the fire risk in a building, particularly where large quantities of piping may otherwise be exposed.

11.2 In England and Wales the detailed requirements are given in Approved Document B.

11.3 In Scotland and Northern Ireland, pipes which penetrate separating or compartment walls or floors must be constructed or protected so that in the event of fire the fire resistance required for the wall or floor is maintained, and they must be fire-stopped.

## 12 Maintenance



Sections of the system can easily be removed and replaced. The installation must be designed so that access is provided in accordance with BS EN 12056-2 : 2000, clause ND4.

## 13 Durability



In the opinion of the BBA, when used in the context of this Certificate, the materials from which the component parts of the pipes and fittings are manufactured will not significantly deteriorate, and the system will have serviceable life equivalent to PVC-U sanitary pipework systems.

## Installation

### 14 Procedure

14.1 Installation must be in accordance with the manufacturer's literature and the recommendations given in BS EN 12056-2 : 2000 and BS EN 12056--3 : 2000, where appropriate.

14.2 End-to-end butt weld joints must be carried out under controlled conditions as follows:

- pipe must be cut square and clean using a Terrain Pipe Cutter (outside the scope of this Certificate)
- the welding plate must be clean
- the required lateral pressure must be applied
- appropriate heat-up and weld time should be used.

14.3 The welding procedure is as follows:

- the face of each item is heated by lightly pressing the components against the heating plate for the correct period
- clamping pressure is gradually increased to the required value and held for the specified period
- clamps and jigs are available to ensure correct alignment of the joint.

14.4 Electroweld joints using the appropriate Terrain Welder (outside the scope of this Certificate) must be carried out as follows:

- the pipe end and sleeve must be kept dry at all times
- the pipe is cut off at right-angles, deburred, scraped and cleaned
- the pipe or fitting is inserted into the sleeve to the central register, and the welder is connected to the sleeve and operated in accordance with the manufacturer's instructions.

14.5 Other types of connection sleeve must be butt welded to the spigot to be joined, in accordance with sections 14.2 and 14.3. The connection is made according to the joint type as follows:

- ring-seal socket — the pipe or fitting spigot is chamfered, lubricated and pushed fully into the socket
- expansion socket<sup>(1)</sup> — the pipe is chamfered, lubricated and pushed the appropriate length into the socket, depending on the temperature at the time of installation. (see Figure 1)
- screw-threaded fittings are connected to spigots by inserting the spigot fully into the joint and tightening the locking collar by hand.

(1) Expansion sockets should be protected from the ingress of dirt.

14.6 The pipes are secured by anchor brackets on hangers (outside the scope of this Certificate). The maximum spacing of the supports must be ten times the pipe diameter for vertical and horizontal pipes.

### 15 Investigations

15.1 An examination was made of data relating to:

- material properties
- dimensions in relation to BS EN 1519-1 : 2000
- installation
- thermal shock
- heat reversion
- melt-flow index
- resistance to pressure.

15.2 The manufacturing process was evaluated, including the methods adopted for quality control, and details were obtained of the quality and composition of the materials used.

### Bibliography

*BS EN 1519-1 : 2000 Plastics piping systems for soil and waste discharge (low and high temperature) within the building structure — Polyethylene (PE) — Specifications for pipes, fittings and the system*

*BS EN 12056-2 : 2000 Gravity Drainage Systems inside Buildings — Sanitary pipework, layout and calculation*

*BS EN 12056-3 : 2000 Gravity Drainage Systems inside Buildings — Roof drainage, layout and calculation*

*BS EN ISO 9001 : 2015 Quality management systems — Requirements*

*BS EN ISO 14001 : 2004 Environmental management systems — Requirements with guidance for use*

*CP 312-1 : 1973 Code of practice for plastics pipework (thermoplastics material) — General principles and choice of material*



### 16 Conditions

#### 16.1 This Certificate:

- relates only to the product/system that is named and described on the front page
- is issued only to the company, firm, organisation or person named on the front page – no other company, firm, organisation or person may hold claim that this Certificate has been issued to them
- is valid only within the UK
- has to be read, considered and used as a whole document – it may be misleading and will be incomplete to be selective
- is copyright of the BBA
- is subject to English Law.

16.2 Publications, documents, specifications, legislation, regulations, standards and the like referenced in this Certificate are those that were current and/or deemed relevant by the BBA at the date of issue or reissue of this Certificate.

16.3 This Certificate will remain valid for an unlimited period provided that the product/system and its manufacture and/or fabrication, including all related and relevant parts and processes thereof:

- are maintained at or above the levels which have been assessed and found to be satisfactory by the BBA
- continue to be checked as and when deemed appropriate by the BBA under arrangements that it will determine
- are reviewed by the BBA as and when it considers appropriate.

16.4 The BBA has used due skill, care and diligence in preparing this Certificate, but no warranty is provided.

16.5 In issuing this Certificate the BBA is not responsible and is excluded from any liability to any company, firm, organisation or person, for any matters arising directly or indirectly from:

- the presence or absence of any patent, intellectual property or similar rights subsisting in the product/system or any other product/system
- the right of the Certificate holder to manufacture, supply, install, maintain or market the product/system
- actual installations of the product/system, including their nature, design, methods, performance, workmanship and maintenance
- any works and constructions in which the product/system is installed, including their nature, design, methods, performance, workmanship and maintenance
- any loss or damage, including personal injury, howsoever caused by the product/system, including its manufacture, supply, installation, use, maintenance and removal
- any claims by the manufacturer relating to CE marking.

16.6 Any information relating to the manufacture, supply, installation, use, maintenance and removal of this product/system which is contained or referred to in this Certificate is the minimum required to be met when the product/system is manufactured, supplied, installed, used, maintained and removed. It does not purport in any way to restate the requirements of the Health and Safety at Work etc. Act 1974, or of any other statutory, common law or other duty which may exist at the date of issue or reissue of this Certificate; nor is conformity with such information to be taken as satisfying the requirements of the 1974 Act or of any statutory, common law or other duty of care.