

TERRAIN

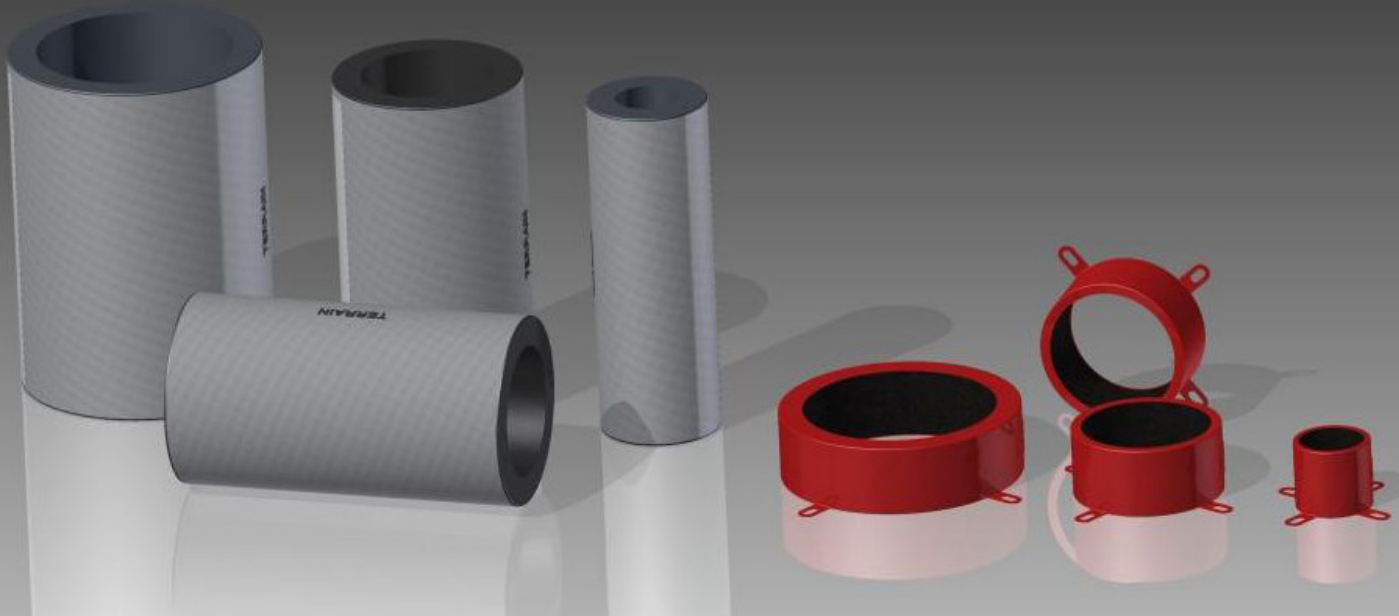

Terrain Firetrap

Fire protection for above ground drainage systems

TERRAIN FIRETRAP

The best fire rating available for the drainage stack

As part of the on-going development of Terrain drainage systems, we have developed a comprehensive range of passive fire protection products for use with Terrain PVC soil and waste, Terrain Fuze and Terrain dB12. These products will enable secure specification of Terrain drainage systems with the confidence of conforming to the requirements of Part B Building Regulations. In addition all products comply with BS 476 Part 20 and BS EN 1366-3.



The Terrain Firetrap range comprises:

Terrain Firetrap Sleeves

- Ideal for Terrain Fuze stacks
- Up to 4 hour fire protection
- Quick to install in new build and retro-fit
- Protects compartment above and below slab

Terrain Firetrap Collars

- Suitable for all Terrain drainage systems
- Can be surface mounted or built in
- Up to 2 hour fire protection

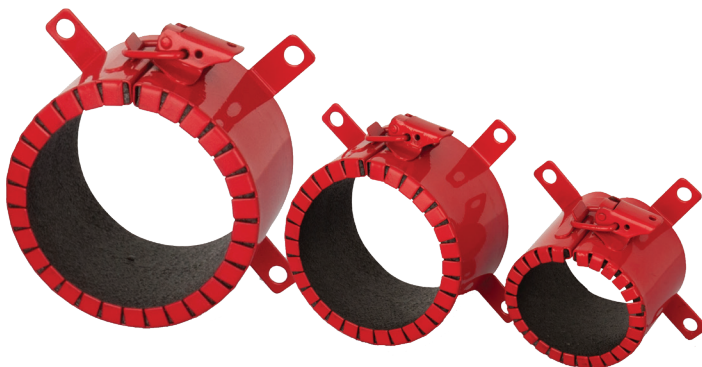

In addition, independent testing has been carried out on both Firetrap Sleeves and Firetrap Collars in typical floor installations.

Contents

Firetrap Sleeves	Pages 4-5
Firetrap Collars for Terrain PVC, Terrain FUZE and Terrain dB12	Pages 6-7
Construction Details and Fire Rating	Page 8
Installation of Firetrap Sleeves	Page 9
Installation of Firetrap Collars for Terrain PVC, Terrain FUZE and Terrain dB12	Page 10
Standards and Certification	Page 11

Firetrap Sleeves

The Terrain Firetrap Sleeve is a cost effective product for the fire stopping of pipe penetrations whilst maintaining similar thermal and acoustic properties as standard mineral fibre insulation.

Terrain Firetrap Sleeve was developed with ease of installation in mind. The sleeve can be quickly and simply fitted onto the pipe and slid into the penetration ensuring that there are no air gaps around the sleeves by filling with mortar or mastic. In a fire situation the sleeve expands to fill the available space (15mm max) between the pipe and the penetration and will crush and close off plastic drainage pipes. The pipe forms a solid char preventing the passage of fire and smoke to the adjacent compartment.



Terrain Fuze



Terrain dB12



Terrain PVC Soil and Waste

Applications

Terrain Fuze, Terrain dB12 and Terrain PVC soil and waste above ground drainage through:

- Concrete, masonry or plasterboard partitions
- Concrete floor constructions

Benefits

- Up to 4 Hour Fire Rating to BS 476 Part 20, BS EN 1366-3
- Protects pipe above and below the slab
- Cost effective
- One sleeve can replace two collars
- Easy installation
- Don't have to drill slab
- No need for mechanical fixings
- No mastic is required, providing close fit
- Easily cut to size to minimise wastage
- Simple to install without special tools or skills
- Will accept hole irregularities of up to 15mm
- Can be retro-fitted
- Offers excellent acoustic insulation
- Maintains the thermal insulation of the pipe through the slab or wall penetration
- Maintains vapour seal of existing insulation
- Allows for thermal movement of pipe



Terrain Firetrap Sleeve was developed with ease of installation in mind.

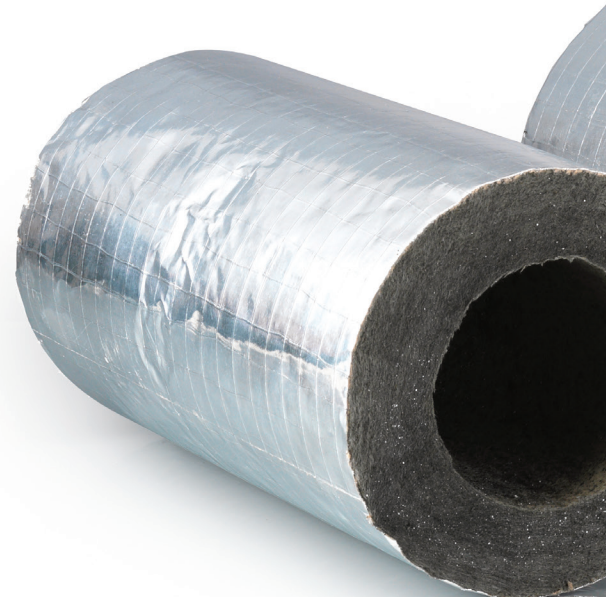

Product Code	Di	Ø	Pipe size suitable for
1925.17	17mm	67mm	
1925.21	21mm	71mm	
1925.27	27mm	77mm	
1925.34	34mm	84mm	32mm
1925.42	42mm	92mm	40mm 32mm PVC
1925.48	48mm	98mm	40mm PVC
1925.54	54mm	104mm	50mm
1925.60	60mm	110mm	56mm 50mm PVC
1925.67	67mm	117mm	63mm
1925.76	76mm	126mm	75mm

Product Code	Di	Ø	Pipe size suitable for
1925.80	80mm	130mm	
1925.89	89mm	139mm	82mm
1925.102	102mm	152mm	90mm
1925.108	108mm	158mm	
1925.114	114mm	164mm	110mm
1925.127	127mm	177mm	125mm
1925.134	134mm	184mm	
1925.140	140mm	190mm	
1925.159	159mm	209mm	
1925.169	169mm	219mm	160mm

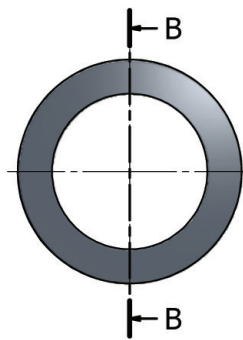
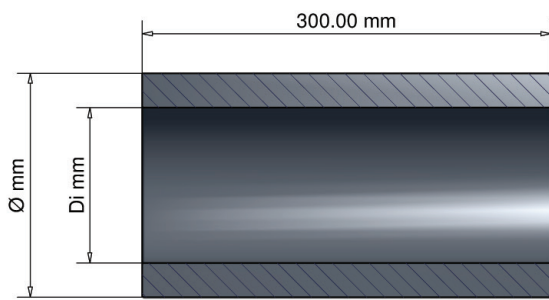

Firetrap Collars - for Terrain PVC soil and waste, Terrain FUZE and Terrain dB12

Terrain Firetrap Collars have been specifically designed to re-instate the fire resistance of a wall or floor which has been penetrated by services such as Terrain PVC, Terrain FUZE or Terrain dB12

Manufactured in steel, each fire collar contains an internal lining of intumescent graphite impregnated organic polymer. Anchoring hooks are also supplied. The collars will seal pipes from 50mm to 315mm diameter and can be face fixed or set into a wall or ceiling structure. They are suitable for use on concrete, masonry and plasterboard partitions. They have a 2 hour fire rating and feature mounting tabs for quick and easy installation.

Applications

For Terrain PVC soil and waste, Terrain FUZE and Terrain dB12 above ground drainage through:

- Concrete, masonry and plasterboard partitions
- Concrete floor construction
- Fire proof concrete
- Brickwork floors and walls

Features

- 2 hour fire rating
- Powder coated steel sleeve
- Can be surface mounted or built in
- Mounting tabs for quick and easy installation
- Seals against smoke, toxic gases, flames and heat
- Can be installed in a recessed area to minimise overall dimensions





Product Code	Ø	Fire Rating
1625.40R	40mm	2 hour
1625.55R	55mm	2 hour
1625.63R	63mm	2 hour
1625.75R	75mm	2 hour
1625.82R	82mm	2 hour
1625.90R	90mm	2 hour
1625.110R	110mm	2 hour
1625.125R	125mm	2 hour
1625.160R	160mm	2 hour
1625.200R	200mm	2 hour
1625.250R	250mm	2 hour
1625.315R	315mm	2 hour

Collars will seal pipes from 40mm to 315mm diameter and can be faced fixed or set in to a wall or ceiling structure.

Construction Details

Fire protection for vertical Terrain Drainage Pipework in a NON fire rated duct

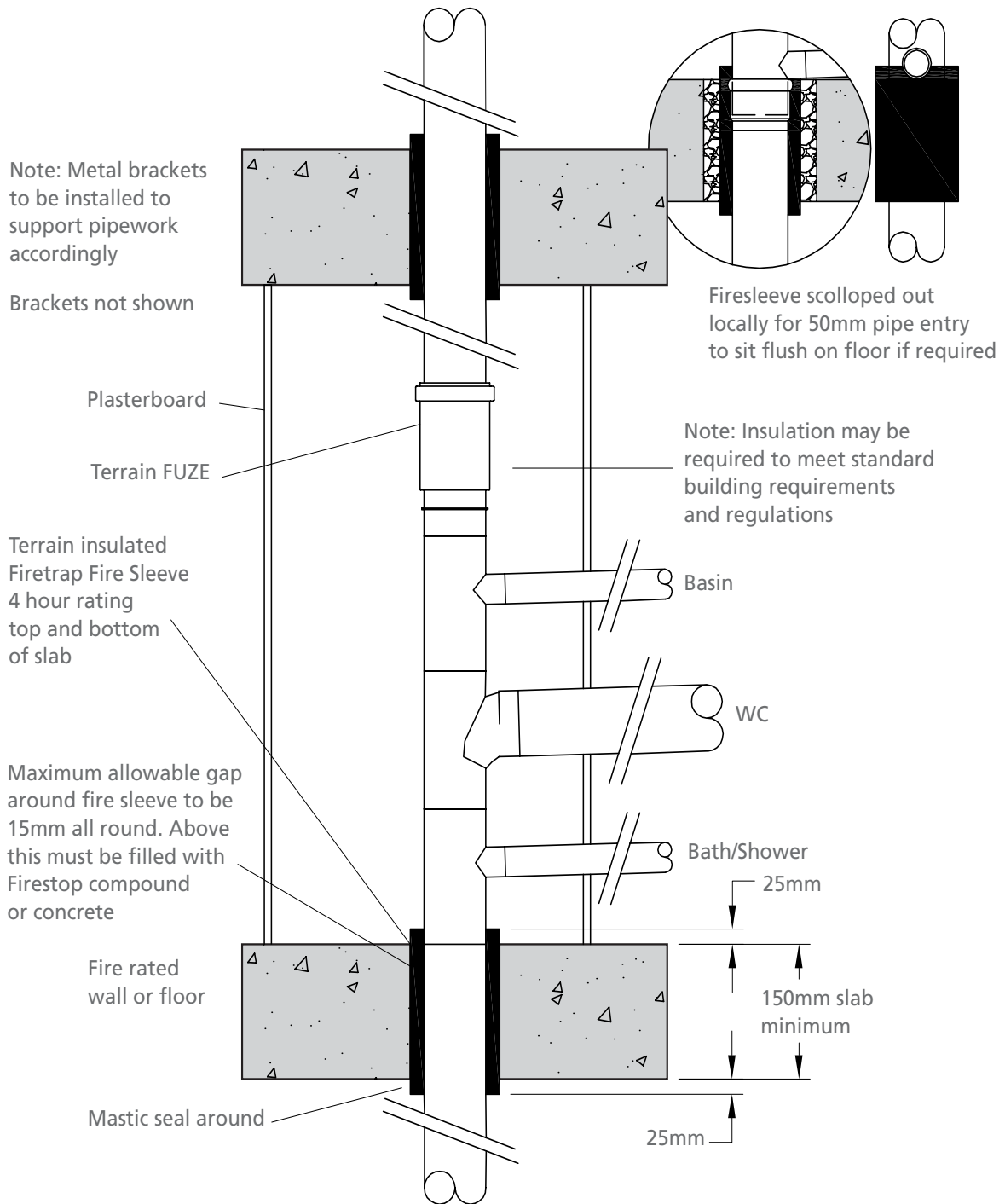

Installation - Firetrap Sleeves

To maintain the fire rated compartment between floor levels where Terrain drainage penetrates the slab, an insulated fire sleeve should be installed. The fire sleeve should be installed through the entire slab penetration. Where possible a maximum of 25mm of sleeve can be left protruding out of the slab both at floor level and the underside of the slab. If, due to low level connections at slab level, this method is not possible then two alternative methods can be used;

1. Maintain the 25mm protrusion but scollop out the sleeve locally to accommodate the low level connection.
2. Cut the sleeve flush with the slab/soffit level.

Where possible the sleeve shall be installed by sliding it over the pipe to be protected prior to installation and once the pipe is installed the sleeve shall be slid in to its finish position. Ensure that it doesn't slide out of position with either mortar or mastic.

If this is not possible then the sleeve can be slit along its length and fitted around pipes already in-situ. If this method is used then foil tape shall be used to join the two mating faces.

The sleeve can be fitted into pre-cast holes that are to be made good. The material used to make good can be poured into the shuttered hole and the material can be allowed to flow directly onto the sleeve outer diameter which is foil protected.

Alternatively the sleeve can be fitted into a core drilled hole provided the hole is no more than 15mm larger than the outside diameter of the sleeve. If this method is used then a fire rated mastic should be used to protect the gap between the sleeve outside diameter and the slab.

If acoustic insulation is used on the main body of the stack then this insulation can be jointed to the fire sleeve by using foil tape at the mating faces.

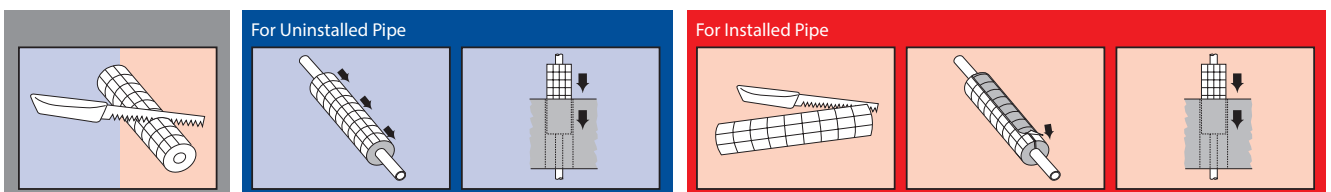

Step One: Cut sleeve to required length i.e. penetration thickness plus 50mm to allow for 25mm to protrude either side of the penetration

Step Two: Slide sleeve along the pipe prior to installation

Step Three: Slide pipe and sleeve into cavity. Leave 25mm protruding out of the top and bottom of the slab

Step Two: Make a single slit along the sleeve length to allow fitting around installed pipe

Step Three: Fit sleeve around pipe and re-seal the cut with foil sealing tape supplied

Step Four: Slide sleeve along pipe and into cavity. Leave 25mm protruding out of the top and bottom of the slab. Tape sleeve to existing insulation if required

Installation - Firetrap Collars for Terrain PVC, Terrain FUZE and Terrain dB12

1. How to install the fire collar

Drill a hole through the wall/floor using a corer and crown bit in required size. Install the plastic pipe. Seal the gap between the hole and the pipe. If a wide gap exists, the space must be sealed using fire-proof mortar or alternatively, an intumescent sealing agent.

2. Pipe cleaning

A sealing effect is achieved with the expansion of the intumescent material during the fire which completely seals the plastic pipes. Mortar residue and dirt will impede this sealing effect, so cleaning of the pipes is essential at the point where the fire collar is fitted.

3. Closure and seal against smoke and gas

The intumescent material will seal the gap when activated by high temperature and fire. To protect against the spread of smoke and gas within the first few minutes the remaining gap between the plastic pipe and the opening must be sealed on one side of the wall using an appropriate sealing agent.

4. Closing the fire collar

No tools, pins or screws are required to lock the collar in place. Simply position the fire collar around the plastic pipe and press firmly to tighten the closing device until the mechanism snaps into place. Ensure the collar is positioned correctly to enable the anchoring hooks to be fixed.

5. Locking the fire collar

The fire collar can only protect against fire if it is adequately fixed in place. The use of anchoring devices is recommended to secure the collar in place.

6. Recessed installation

Ensuring that the hole is sufficiently wide enough to accommodate the external diameter of the fire collar, insert the fire collar into the opening. The fire collar must be installed flush with the lower surface when installed at ceiling level. Insert one collar on each side in the case of a wall installation, if a gap remains around the installed collar, this must be filled with mortar.

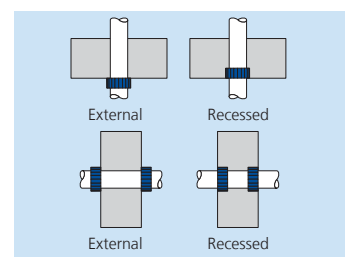
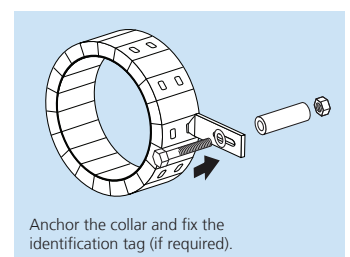
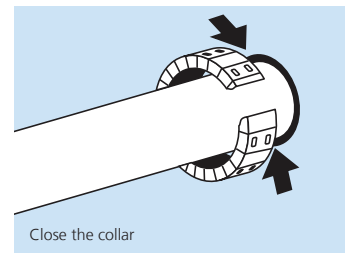
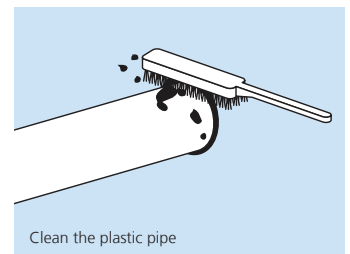
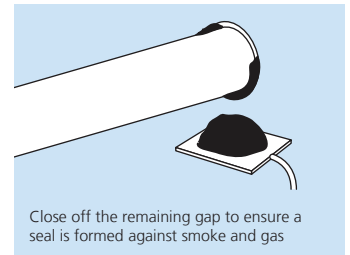

Standards and Certification

Steps must be taken that comply with the provisions of the National certificates issued for the product when a fire-proof seal is made for the passage of pipes using fire-proof intumescent collars.

Terrain recommends referring to the product's certificates to verify the limitations with regards to the size of the opening, type and thickness of the wall or floor and the maximum diameter of the pipes. Local Fire Regulations should always be consulted in accordance with Building Regulations Part B.

[Firetrap Sleeves for Terrain FUZE](#)

[Fire Testing](#)

Terrain Firetrap Sleeves are fire tested in accordance with BS 476: Part 20: 1987, BS EN 1366-3.

Constructions covered - Plasterboard partition and Solid walls and floors.

Chiltern International Fire testing reports available on request.

[Acoustic Testing](#)

Firetrap Sleeves were acoustically tested in a plasterboard partition system under UKAS conditions in accordance with BS EN ISO 140-3:1995 and BS EN ISO 717-1:1997 to be fixed.

[Firetrap Collars for Terrain FUZE and Terrain dB12](#)

- Tested to BS 476 Part 20.
- IFC certificate number: FS453/07

Certificate available on request

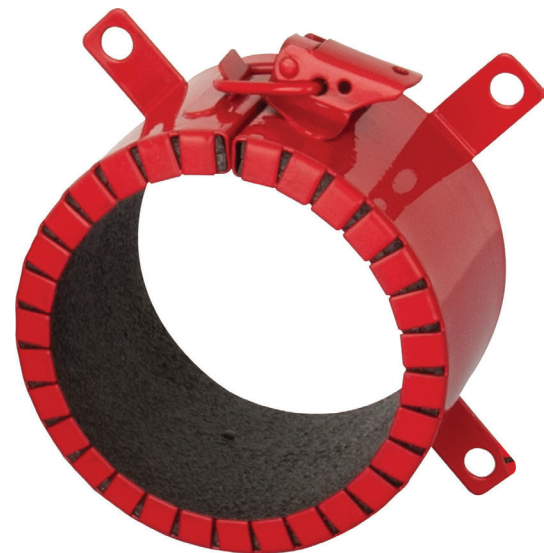

TERRAIN FIRETRAP

Polypipe Building Services

New Hythe Business Park

College Road

Aylesford

Kent

ME20 7PJ

United Kingdom

Tel: +44 (0)1622 795200

Fax: +44 (0)1622 716796

commercialenquiries@polypipe.com

www.polypipe.com/commercial-building-services



FSC

Mixed Sources
Product group from well-managed
forests and other controlled sources

Cert no. SA-COC-001754
www.fsc.org
© 1996 Forest Stewardship Council