



Creating Green Infrastructure

## Treebox HP



Urban Tree Planting System

# Trees for towns and cities

Modern urbanised towns and cities are increasingly becoming warmer, wetter and less hospitable places to live. Flooding, erosion and the rise in the heat island effect are the price we pay for continued but necessary development. One way of helping to reduce these issues is to plant more trees with a wider variety of species and sizes.



## Planting trees in almost impossible situations

The **TreeBox HP** system is the ideal solution for providing trees with the soil volumes needed to establish, grow and mature.

Research has proven that trees with access to high volumes of soil grow larger and survive longer. Underground services can be accommodated without the need for special access covers or pits.

## Applications

The **TreeBox HP** system has a load capacity of 60 tonnes and is suitable for all types of load bearing applications including:

- Car parks
- Service vehicle access areas
- Estate roads
- City centre shared pedestrian and vehicular access areas
- Steetscapes

The desire for mature trees in the city, the shortage of underground space and extreme conditions, were the inspiration for the development of the **TreeBox HP**. The system combines high strength concrete supports and cover slabs with plastic wall cells. The **TreeBox HP** creates a structural wall which sits around the concrete supports.

A large void is created which can be filled with soil or tree sand depending on whether the application is for sustainable drainage or just tree growth. The concrete covers provide a load bearing surface which can be overlaid with any hard landscape surfacing material.

Since its introduction during 2003 and after successful trials with the City of Amsterdam the system has evolved and installation methods have significantly improved.

The **TreeBox HP** system is one of the most cost effective solutions to providing high volumes of uncompacted tree soil in urban areas. The result of this is larger trees and even greater benefits when combined with the source control of surface water run off.

## System Benefits

- Promotes large tree growth
- High load capacity
- Suitable for all types of pavements
- Tree roots have perfect growing environment
- Ease of passage and access for services
- Permeable structural walls
- Can form part of a Sustainable Drainage system



# Installation

A step by step guide to the installation process for the **TreeBox HP**

---

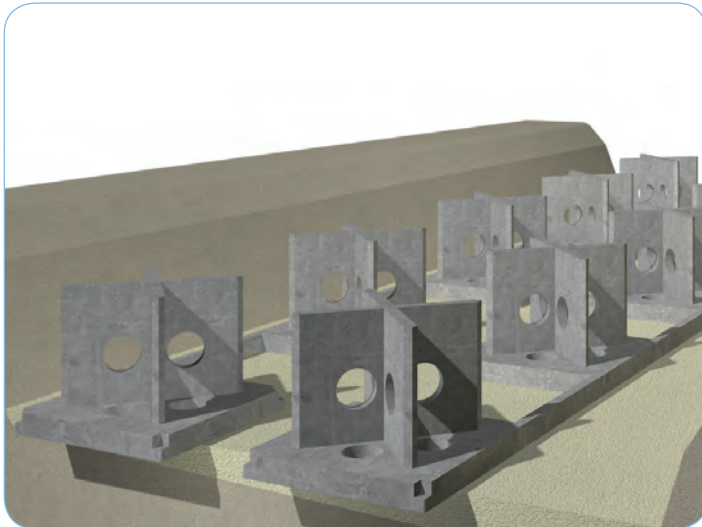

## Step 1

Concrete supports are placed in situ. The TreeBox wall units are then installed and wrapped in a geotextile to form a breathable wall. The area between the TreeBox HP walls and the excavation is simply filled with granular material and compacted.

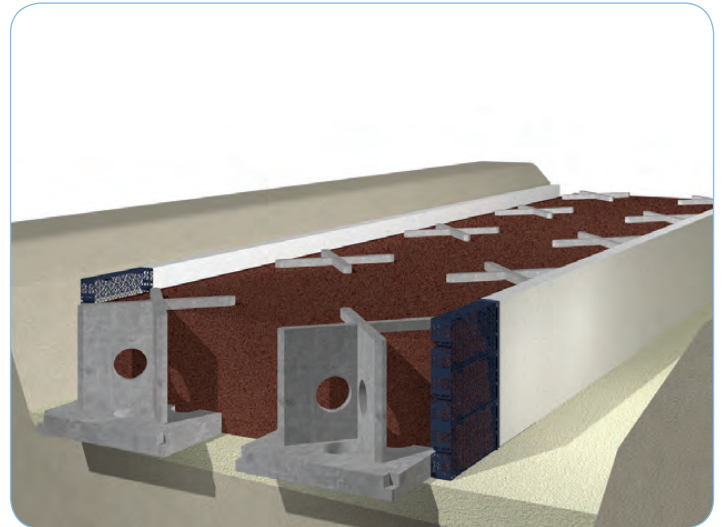

## Step 2

Backfilling of the tree pit can be carried out mechanically and no compaction of the soil is necessary apart from walking out any air pockets. The finished level of the soil is equal to the top of the concrete supports, this creates an air gap between the cover and the soil which will prevent roots from penetrating.

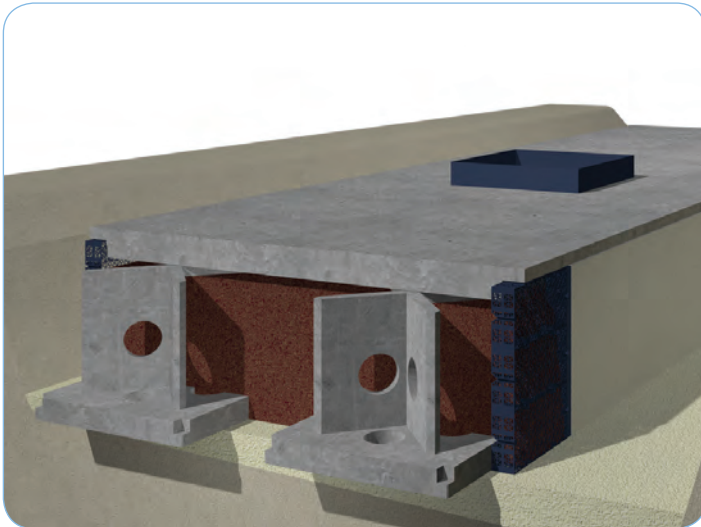

### Step 3

Once the soil has been placed the concrete covers are installed. Aeration and watering systems can be placed prior to the covers being installed. The perforated covers are recessed to connect with the TreeBox HP units securely and are recessed at the planting hole to allow for the tree positioning. In the tree pit a HDPE collar can be fitted (if required) to ensure good integration between the tree and the new rooting area.

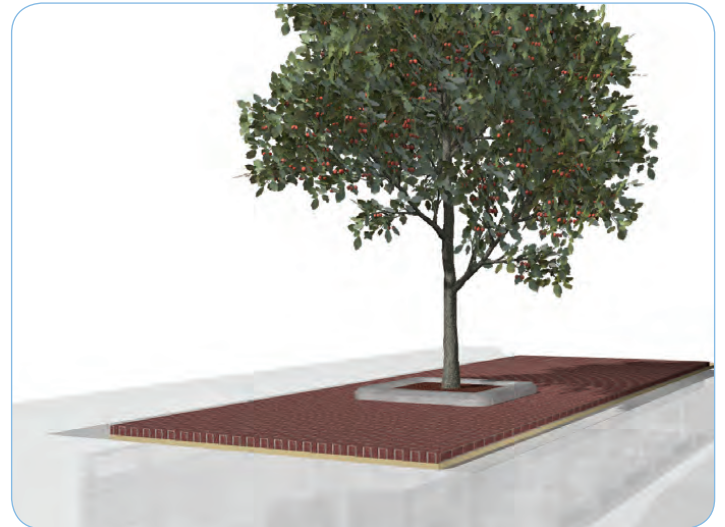

### Step 4

A permeable geotextile is placed on top of the concrete covers with the final surfacing placed directly above this layer. We recommend a porous surface, however, drainage systems can be designed to accommodate normal impervious pavements.

The finished installation provides a perfect habitat for newly planted trees to establish in unnatural environments. The soil remains uncompacted even under the most severe traffic loadings.

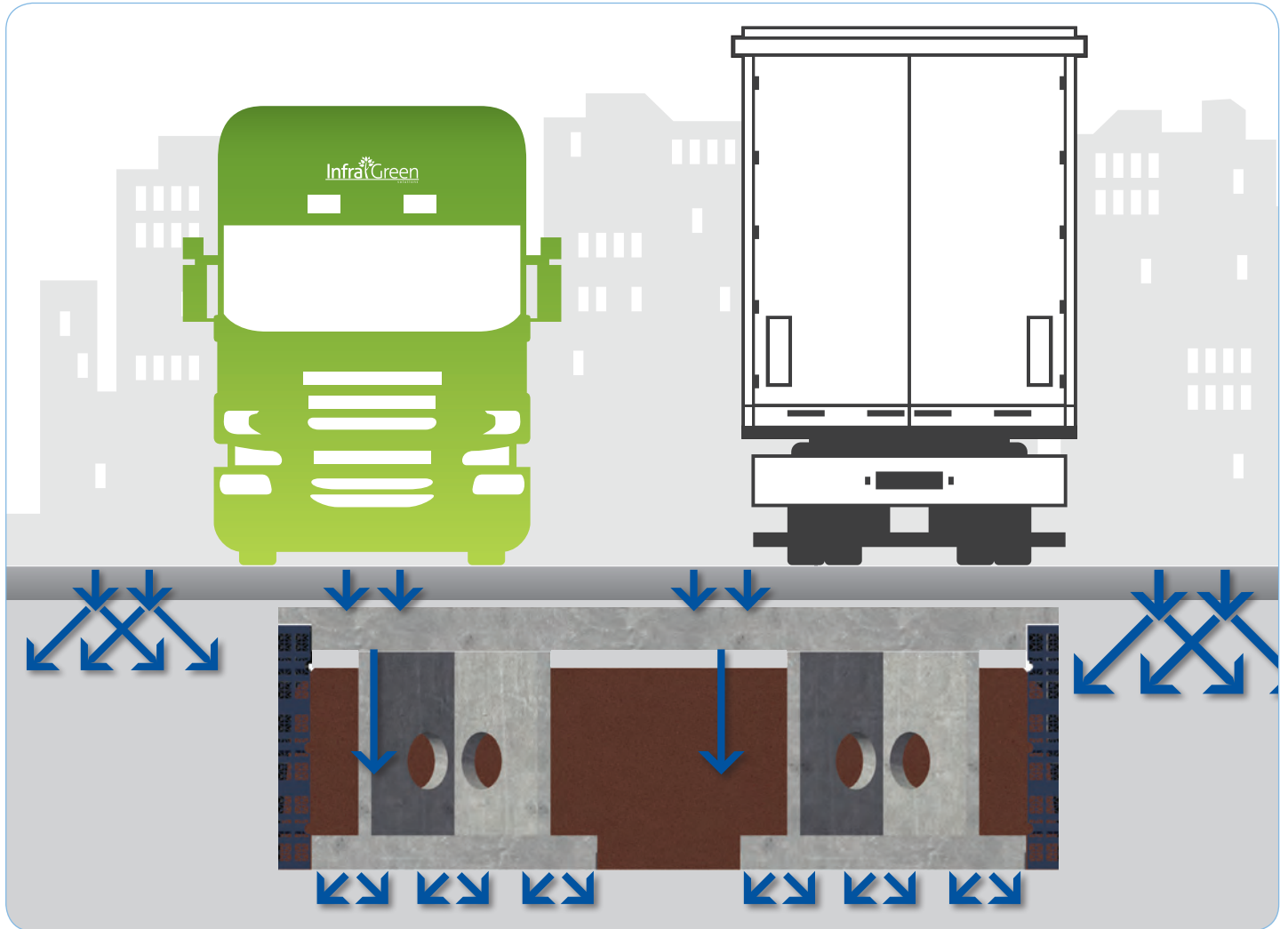

# Tree Ground

The **TreeBox HP** is suitable for all types of infill soils. Soils rich with minerals, oxygen and beneficial micro-organisms can be used or a bio-retention soil with a higher sand content can be used for handling surface water run off in sustainable drainage applications.

The fertility of the soil can be maintained easily by using the air gap in the top of the installation to feed and water the tree soil periodically.

Subject to a favourable ground investigation report, the excavated material may be re-used within the **TreeBox HP** system.

This will reduce the total installation cost and the carbon footprint of the installation over traditional planting systems.

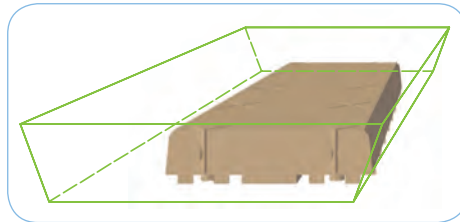
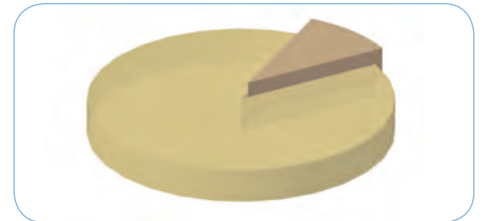
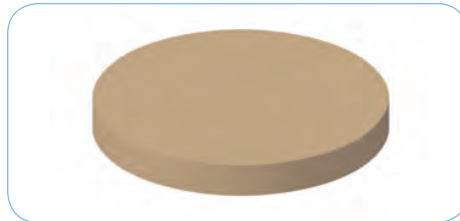

The **TreeBox HP** is designed to be a bespoke solution to a tree planting project. Every project should be assessed on its own merits and existing soil conditions should be considered. It is important to place the right tree in the right location to ensure the tree species selected will survive long term.

# Flexible Design

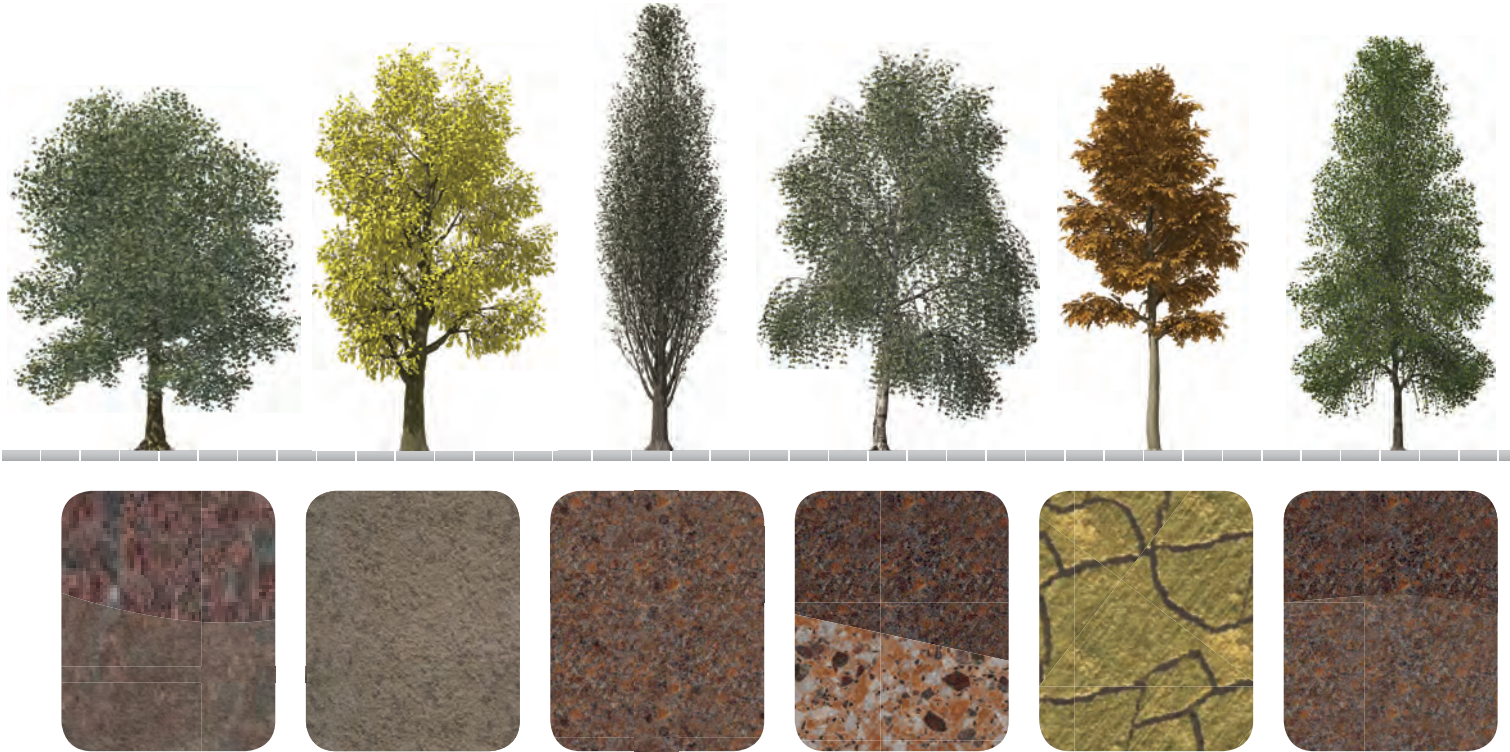

Modern urbanised towns and cities are increasingly becoming warmer, wetter and less hospitable places to live.

## Existing Trees

Improving and increasing the rooting areas of existing trees in hard landscapes is possible with our **TreeBox HP** retrofit modules.

The retrofit units are easy to install and compatible with standard **TreeBox HP** components. As with the standard system, the retrofit modules can incorporate watering and aeration systems.



**Our technical team are available to provide designers with bespoke solutions.** Site specific design advice is part of our service. We recommend thorough site investigations are undertaken on the proposed planting areas to ensure there is sufficient space for the new rooting structure and to assess if the existing soil can form part of the new planting scheme.



# Ancillary Components

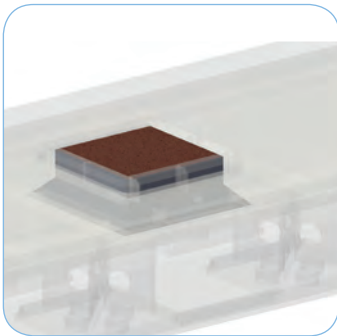

**Plastic collar**

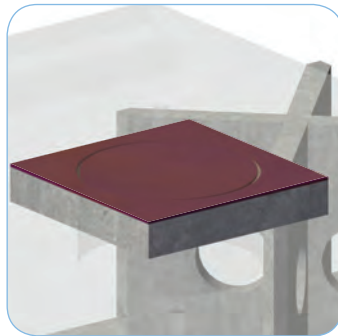

**Inspection points**

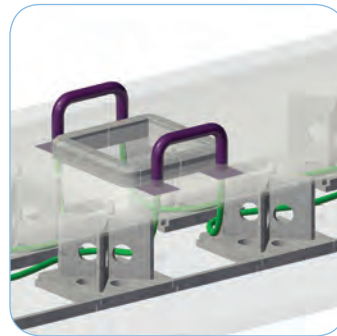

**Aeration systems**

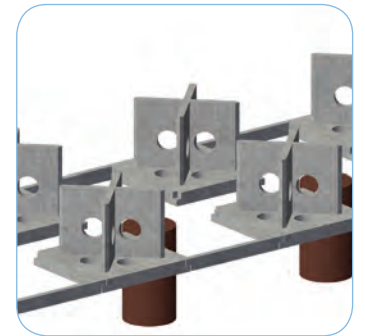

**Anchoring systems**

The TreeBox HP has a number of ancillary products to complement the system, including irrigation, aeration and anchoring systems. The TreeBox HP has been continually developed over the past decade and this has resulted in reductions to the installation timeframes and costs.

# Big Trees, Big Benefits!

The **TreeBox HP** is the perfect solution for providing large uncompacted volumes of soil for new trees in hard landscapes.

Research and development and many successful installations over the past decade allow performance to be guaranteed for a minimum of 35 years.

---

## Backfill 3125 x 3125mm

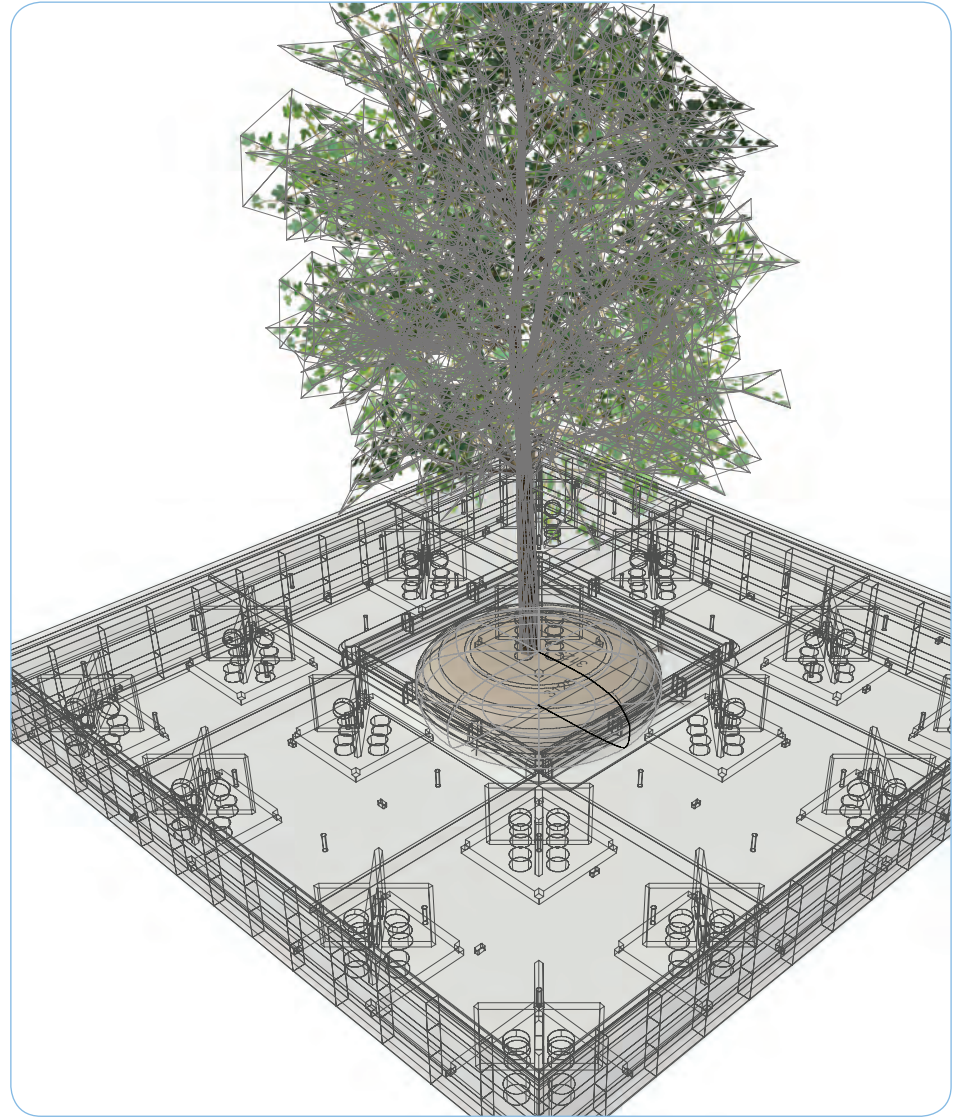
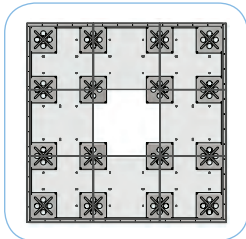
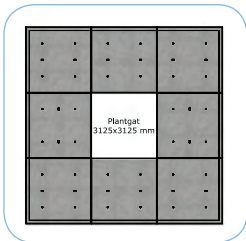

# Flexible Design

The **TreeBox HP** system may be used in small planting pits or large continuous trenches to provide rooting space for the trees to grow to their optimum size.

Please contact our technical team for site specific advice.

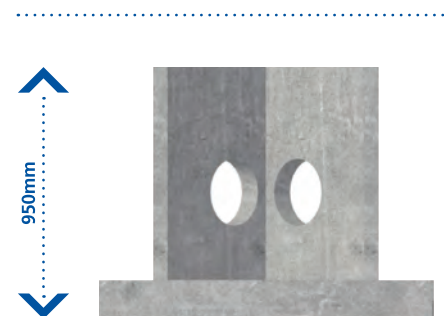
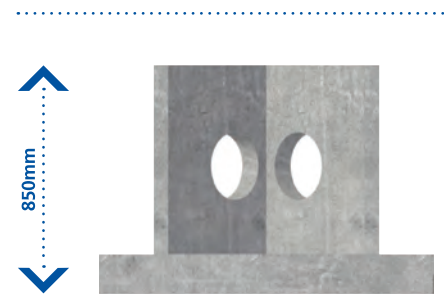
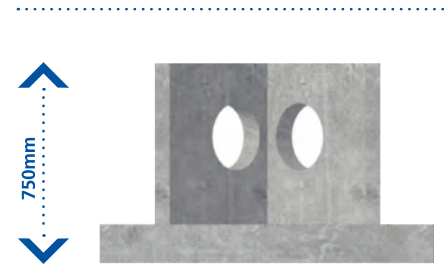
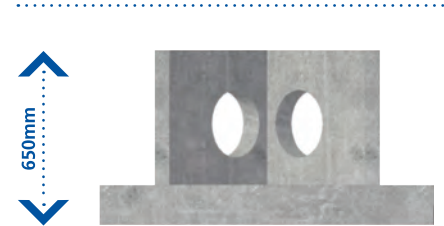
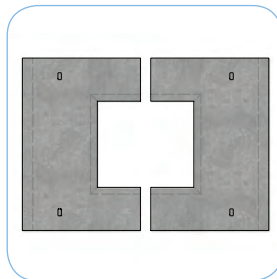
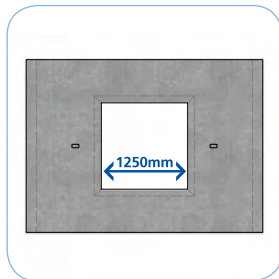
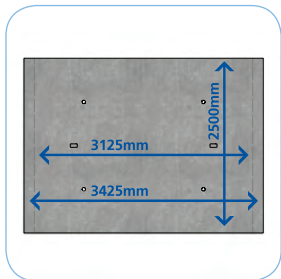
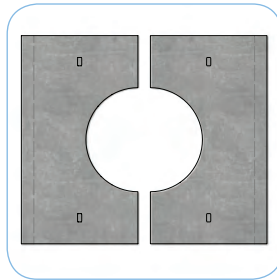
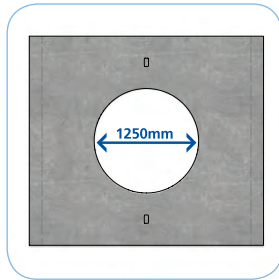
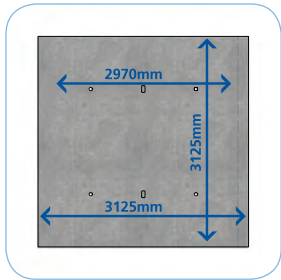
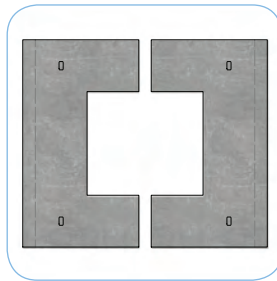
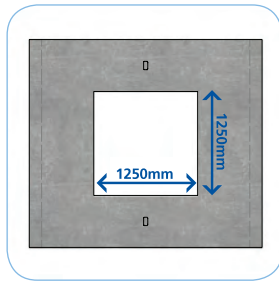
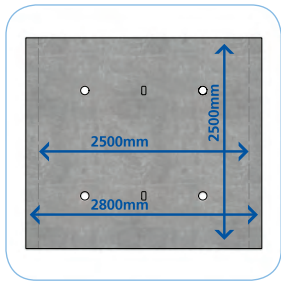
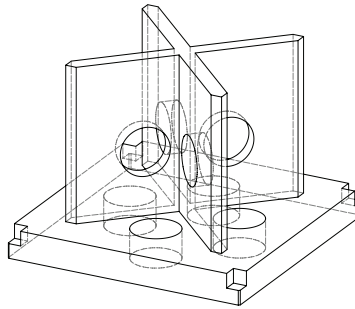

# Sustainable Drainage Systems (SuDS)

The **TreeBox HP** can form part of an overall sustainable drainage design strategy. Trees can play a significant role in managing surface water run off at source. Over 70% of rainwater that falls on a tree is dealt with by the tree and through the inclusion of bioretention soils within planting space it is possible to accommodate some of the surface water run off.

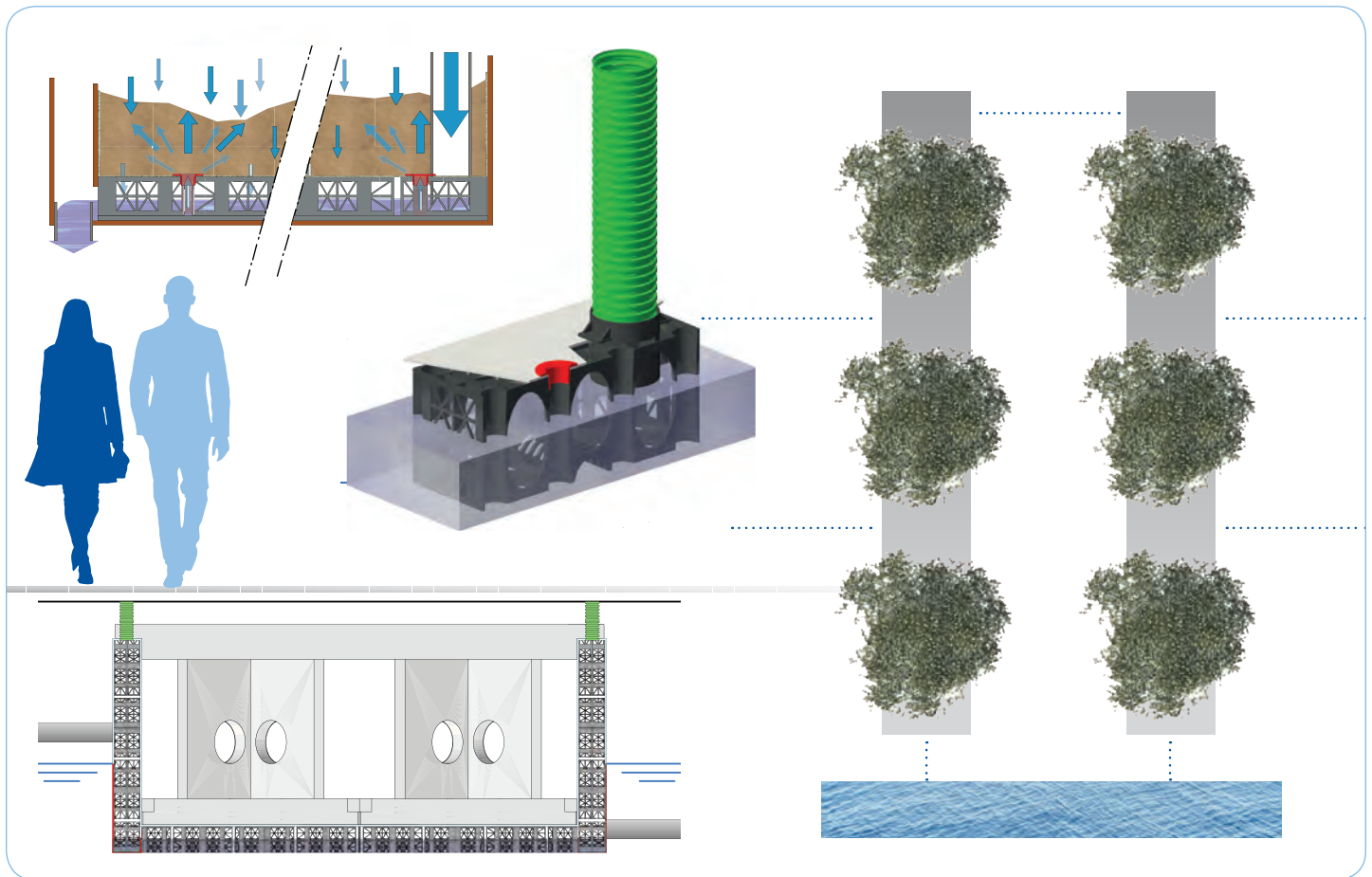



**Planting trees** in almost impossible situations

---

# Other products by **InfraGreen** SOLUTIONS

Infra Green offer plastic permeable paving systems to cover a wide range of applications from simple footpaths and temporary car parking to fully engineered grass and gravel paving systems for heavy goods vehicle parking areas.

## Infra Green's full product range includes:

- ArborRaft tree planting systems
- InfraWeb TRP
- Tree soils and rootzones
- Plastic paving grids for grass and gravel infill
- Turf protection
- Geotechnical products
- Porous rubber tiles for walkways and access areas
- Drainage systems for sports fields and play areas
- Lightweight base systems for rooftop sports and play areas

For further information on any of our products, please contact our office on 01509 615100 or email [civils@polypipe.com](mailto:civils@polypipe.com)



**Plastic paving**



**ArborRaft**



**InfraWeb TRP**



**Sports Pitch**



**Rooftop Sports and Play areas**

## Infra Green can offer:

- Design services
- Onsite support
- Stock holding
- Next day delivery



Creating Green Infrastructure

## Treebox HP

Urban Tree Planting System



**Polypipe InfraGreen**  
Charnwood Business Park  
North Road, Loughborough  
Leicestershire  
LE11 1LE  
Tel: 01509 615100  
Fax: 01509 615215  
Email: [civils@polypipe.com](mailto:civils@polypipe.com)  
[www.polypipe.com/greeninfrastructure](http://www.polypipe.com/greeninfrastructure)