

Pre-Insulated Piping for Heating & Cooling and Hot & Cold Water Supply



Product Installation Guide

Welcome to Polypipe

At Polypipe, conceiving, designing, manufacturing and delivering the most advanced products and systems isn't merely an occupation. It's a passion. One that's based around a few simple beliefs. Expertise isn't an option. Quality always beats quantity. Products are nothing without service and support. Sustainability isn't just a 'green' word. And working with our customers is much better than simply supplying them.

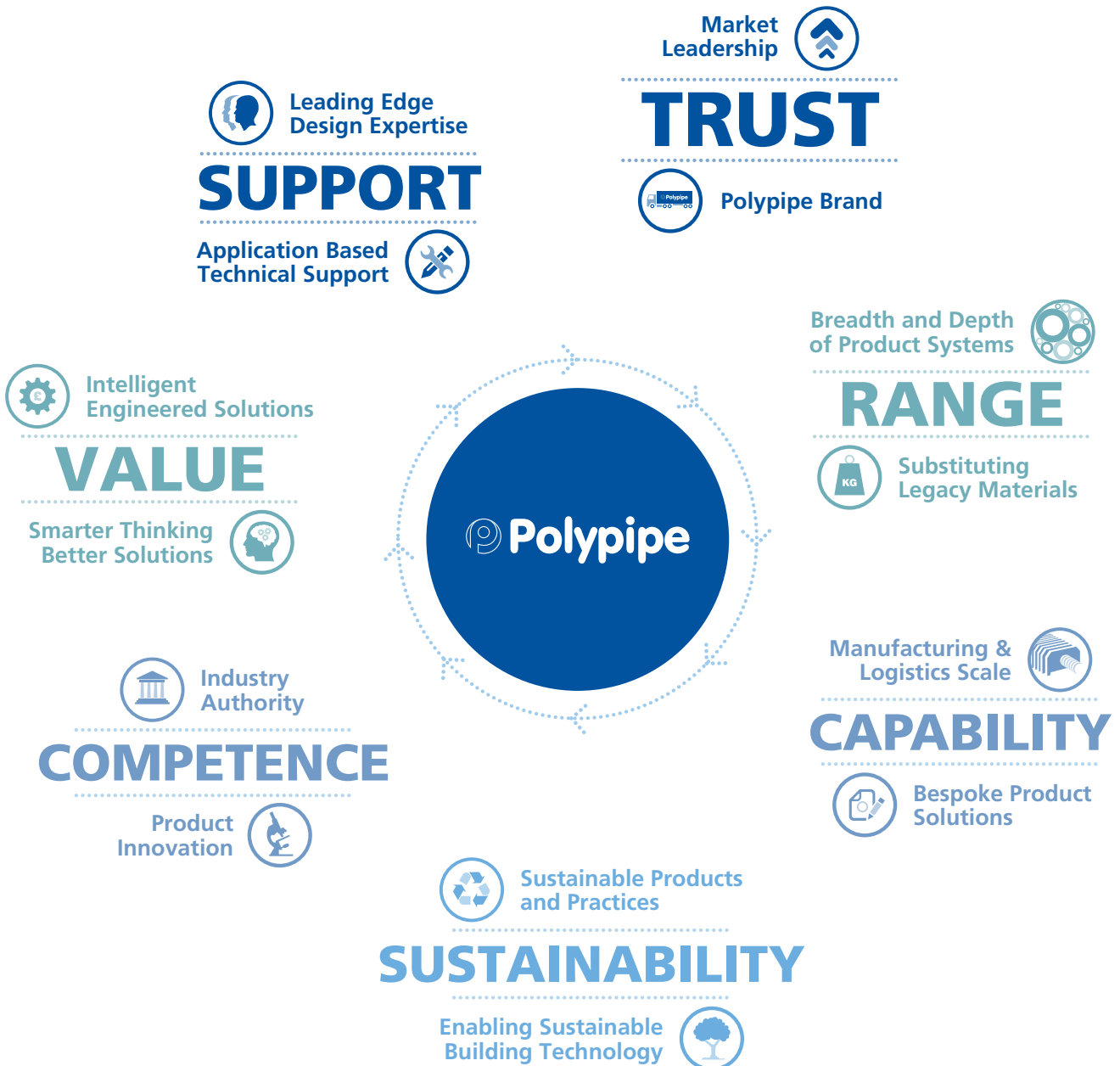

Pre-Insulated Pipe



The unique characteristics of Polypipe Pre-Insulated Pipe: Hyper-Flexibility, durability and availability

Suitable for renewable heating and cooling applications such as ground and air source heat pumps and for hot and cold water supply

Hyper-Flexible - Quick and easy to install with flow and return in one outer pipe

Available - Standard coil packs including fittings and dust caps available from stock

Reliable - Brass mechanical clamp fittings require no special tools or equipment

Durable - Inner PEX barrier pipe and corrugated HDPE outer casing

Hyper-Flexibility:

- Fast installation around bends, obstacles and through walls
- No expansion compensation needed
- No welding required for connections
- No special tools needed
- Light weight facilitates easy installation
- Simple and safe to operate modular system of connections, including couplings and accessories
- Fast installation and accelerated assembly cut installation costs significantly



Durability:

- High-grade raw materials ensure a very long product life
- Unique double wall outside casing in HDPE provides extra protection to the carrier pipes
- Sophisticated geometry of outside casing ensures unparalleled flexibility and high resistance to impacts and pressure
- Hyper-Flexible thermal foam insulation in PE-X with closed cell structure – excellent long-term insulation qualities and high μ factor
- Insulating pipe divider guarantees an effective separation of inlet and outlet pipes
- Corrosion-free carrier pipes in PE-Xa, unique chemical resistance, very long life even under high pressures and temperatures, maximum resistance to cracks caused by ageing
- System pipes are highly resistant to external influences, such as stress, micro biological degradation and temperature swings

Pre-Insulated Pipes



Highly flexible, pre-insulated piping system, combining both the flow and the return medium pipes in the same jacket pipe, primarily intended for the transport of heating water or other heat-transfer media in underground distribution networks and hot and cold water supply.

The medium pipes are made from cross-linked PE-Xa with an orange coloured oxygen-diffusion barrier for the flow line, and a blue coloured for the return. The colour code enables easy identification of flow and return during installation, even with mounted shrink end caps.

The multi-layer thermal insulation is made from cross-linked, microcellular PE-X foam with a water-repellent closed cell structure, characterised by its durable, non-ageing insulation performance, and its permanent elasticity, maximizing the thickness of the insulation layer, even after bending multiple times.

The high-grade, black coloured UV-resistant, double walled, corrugated HDPE sleeve shields the pre-insulated pipe system against mechanical impacts and moisture, whilst maintaining maximum flexibility.

Code	Pre-Insulated Pipes	PE-Xa OD	Wall thickness	PE-Xa ID	Outside casing OD	Weight	Bending radius (1)	Water content (2)	Heat capacity (3)		U value (4)
	Flow & Return distinguished by blue and red pipe	mm	mm	DN	mm	kg/m	m	l/ per m	avg kW	M/s	W/(mK)
PRE1025-2-HTG	25mm x 10mtr Htg Twin Pipe Coil	25	2.3	20.4	140	1.6	0.35	0.654	10-30	0.5 - 1.1	0.221
PRE1525-2-HTG	25mm x 15mtr Htg Twin Pipe Coil	25	2.3	20.4	140	1.6	0.35	0.654	10-30	0.5 - 1.1	0.221
PRE2025-2-HTG	25mm x 20mtr Htg Twin Pipe Coil	25	2.3	20.4	140	1.6	0.35	0.654	10-30	0.5 - 1.1	0.221
PRE1032-2-HTG	32mm x 10mtr Htg Twin Pipe Coil	32	2.9	26.2	140	1.78	0.40	1.078	30-60	0.6 - 1.3	0.262
PRE1532-2-HTG	32mm x 15mtr Htg Twin Pipe Coil	32	2.9	26.2	140	1.78	0.40	1.078	30-60	0.6 - 1.3	0.262
PRE2032-2-HTG	32mm x 20mtr Htg Twin Pipe Coil	32	2.9	26.2	140	1.78	0.40	1.078	30-60	0.6 - 1.3	0.262

(1) The indicated minimum Bending Radius can be applied permanently without affecting the system's quality or performance

(2) The Water Content is expressed in liters per meter length of pre-insulated pipe, including flow + return volume

(3) Heat Capacity in kW for the carrier pipe (at T_{water} of 80°C with a ΔT of 20°C)

(4) The U-value enables easy heat loss calculation, as a function of the driving temperature difference

Code	Packs	Fittings Included		
		Dust Caps	Male Coupling	Fix Point
PRE1025-HTG	Pre Insulated Pack 10m x 25mm F&R	x 2	x 4	x 4
PRE1525-HTG	Pre Insulated Pack 15m x 25mm F&R	x 2	x 4	x 4
PRE2025-HTG	Pre Insulated Pack 20m x 25mm F&R	x 2	x 4	x 4
PRE1032-HTG	Pre Insulated Pack 10m x 32mm F&R	x 2	x 4	x 4
PRE1532-HTG	Pre Insulated Pack 15m x 32mm F&R	x 2	x 4	x 4
PRE2032-HTG	Pre Insulated Pack 20m x 32mm F&R	x 2	x 4	x 4



Code	Insulation Kit	To fit outside casing OD	Length (L)	Jacket Pipe OD	Weight
		mm	mm	mm	kg
INS140IKC	140mm Insulation Kit for Coupler	140	850	160	5.5



Watertight HDPE underground insulation kit for straight extensions of Double pre-insulated pipes. Comes complete with mineral insulation wool, shrink sleeves and installation instructions.

Code	Male Coupling for PEXa pipe	To fit PEX pipe OD / wall thickness	Thread	Diameter (D)	Length (L)	Weight
		mm	inch	mm	mm	kg
INS25MC-HTG	25mm Male Couplings	25/2.3	3/4" M	50	55	0.2
INS32MC-HTG	32mm Male Couplings	32/2.9	1" M	60	65	0.3

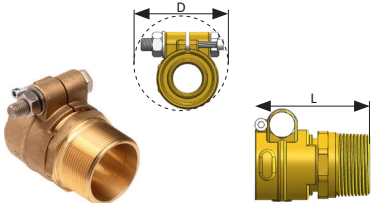

Code	Coupling for PEXa pipe to PEXa pipe	To fit PEX pipe OD / wall thickness	Diameter (D)	Length (L)	Weight
		mm	mm	mm	kg
INS25FC-HTG	25mm x 25mm Coupling	25/2.3	50	80	0.3
INS32FC-HTG	32mm x 32mm Coupling	32/2.9	60	85	0.4

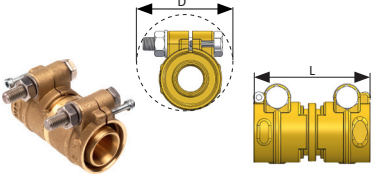

Purpose-designed connectors with long pipe support nipple for superior grip on the PE-X pipe and standardised conical male threads for trouble free connection to any downstream piping. All brass wetted parts are in compliance with the European Drinking Water Directive. Clamping rings in dezincification-resistant (DZR) brass, preventing dezincification corrosion in aggressive conditions. Easy to install bolt type connection without requirement for special tools or hydraulic equipment. Superior quality stainless steel bolts and nuts with reduced cold-welding tendency. O-ring free design, sealing on the PE-X pipe material for a durable leak tight connection.

Code	Fix Point	Thread M & F	Diameter (D)	Length (L)	l	d	Weight
		inch	mm	mm	mm	mm	kg
INS25FP-HTG	25mm Fix Point	3/4"	35	40	8	30	0.1
INS32FP-HTG	32mm Fix Point	1"	45	45	10	40	0.2

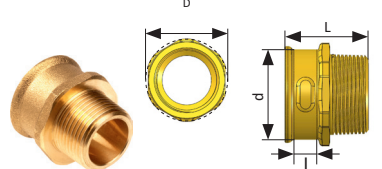

The installation of adequately anchored Fix Points at the extremities of the pre-insulated piping system (typical at wall penetrations) is essential to secure the connected piping against the potential impact of thermal expansion/retraction and longitudinal reversion of the PE-Xa medium pipe(s). Failing to do so involves a genuine damage risk.

Code	Dust Cap
INS140-25-2DC	140mm x 25mm Dust Caps
INS140-32-2DC	140mm x 32mm Dust Caps



Code	Heat Shrink End Cap
INS140-25-2HSC	125mm EPDM Cap
INS140-32-2HSC	160mm EPDM Cap



To prevent ingress of (ground) water, the EN 15632-3 standard prescribes the usage of Shrink End Caps to seal the non-bonded system layers at underground connections. Failing to do so involves a genuine damage risk.

Installation Instructions

1.1 Transport and storage of Pre-Insulated Pipe

Pipes are supplied in coils with a maximum length of 20 metres. Pipe ends are sealed with protective end covers to prevent the entry of pollutants.

In storage, care must be taken to ensure that the PE-Xa carrier pipe is protected from sunlight and that no undesirable deformation of the coil occurs.

Pipes must be transported and stored in such a way that sharp objects, like stones and tree roots cannot damage them. Pipes must not be dragged along the ground. Only nylon or textile straps should be used for fastening the coils during transport.

1.2 Open trench installation

Pre-insulated pipelines can be laid in the ground without difficulties. The corrugated jacket provides the necessary protection for the insulating material and the medium pipe. Installation below 5°C is not recommended.

1.2.1 Trench dimensions

- Always consider the local frost depth to determine the minimum placement depth of the pipes.
- Up to a trench depth of 120 cm, we recommend digging a vertical trench, deeper than 120 cm, we recommend a V-shaped trench. It is most practical to lay the excavated ground alongside the trench.
- Excavation work must be carried out in the approved manner, according to the rules and regulations of local authorities. A prior permission is very often required.
- The depth of the trench must be in accordance with the guidelines of the picture below.

1.3 General installation guidelines

- The pipe may be laid into the trench directly from the coil.
- Position the coil alongside the trench.
- To avoid damaging the outer HDPE jacket, always remove all sharp objects from the ground and lay the pipe in a sand bed.
- When laying larger dimensions and lengths, pulling devices such as winches or tail-end rollers may be used. Always connect these devices to the medium pipe.
- Keep the stated bending radius.
- Remove the packaging foil.
- Place the end of the pipe in position.
- Coils are under tension; don't cut all the straps at once.
- ATTENTION : First cut only the outermost straps. Be careful, when cutting the straps the pipe ends of the coil can spring out!
- Roll the pipe alongside or straight into the trench.
- For double pipes the flow and return must be laid on top of each other.
- Cut the middle straps.
- Roll out further.
- Cut the innermost straps.
- Roll out completely.
- Apply the dust caps or shrink caps.
- Connect the coupling.
- Consider the installation of identification markers on the pipe network and all branches.
- Conduct the pressure test and fill in the report before backfilling.
- Partially fill the trench with a first layer.
- Warning tape or warning mesh positioned above the buried pipes should avoid damaging these pipes when carrying out ground works at a later stage.
- Backfill only after fully covering the pipes with sand, respecting the minimal layer dimensions as indicated in the trench dimension drawing.
- The filling material must be compacted layer per layer.
- From 500 mm the coverage may be compacted by machine.
- All pipe systems intended for potable (drinking) water and other sanitary domestic tasks, such as washing and showering applications, should always be thoroughly rinsed before commissioning, following WRAS requirements.
- The installation of adequately anchored fix points at the systems extremities (typical at wall penetrations) is mandatory. This to secure the connected plumbing against the potential impact of the systems dilatation forces (thermal expansion/retraction).

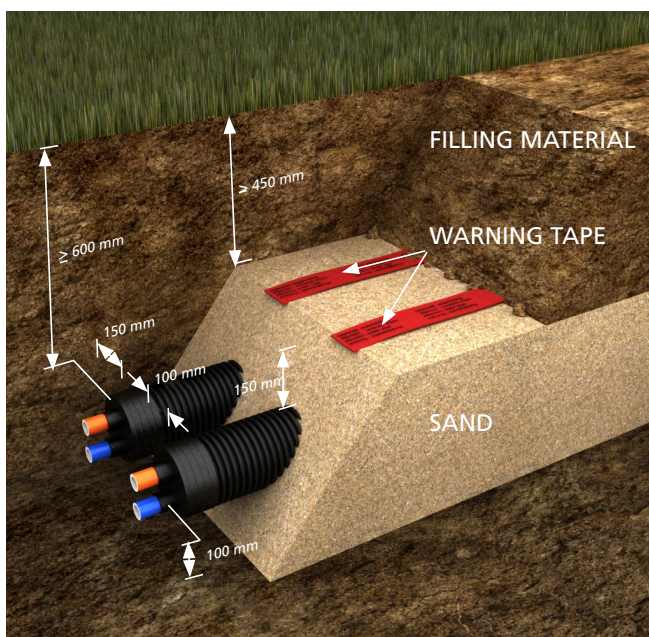

Installation Instructions

1.4 Securing the Pipe

In a trench:

Care must be taken to ensure that a slightly curved line is maintained. In order to keep the pipes in the desired position, the trench may be backfilled with sand at regular intervals.

In buildings:

Fixed points must be installed at entry of buildings. They are necessary to anchor pipes at each end of the pipe run to account for expansion and contraction.

If the installation includes an externally mounted heat pump provision must also be made anchoring to avoid damage to the heat pump.

Attention:

Fixed points must be used to anchor both ends of every pipe run.

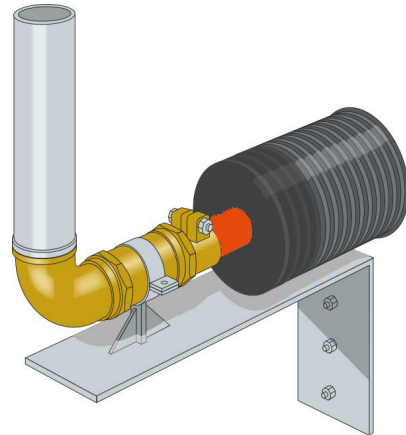

1.5 PE-X Terminal Connectors

01

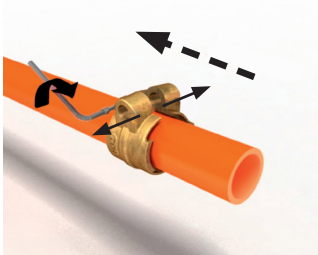

Cut the medium pipe straight across, using plastic pipe cutters and deburr. Spread the clamping ring using a hex key. Slide over the clamping ring as shown, so both jaws of the clamping ring point to pipe end.

02

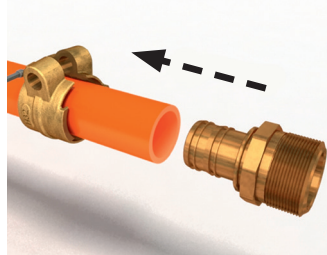

Push the fitting insert completely into the medium pipe until it reaches the collar of the fitting.

03

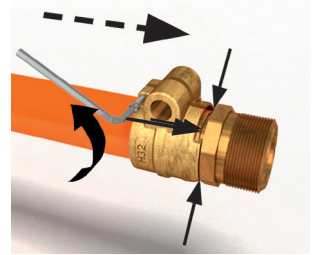

Slide open clamping ring to fitting, until both jaws passed the fitting collar. Unscrew the small bolt by using a hex key.

04

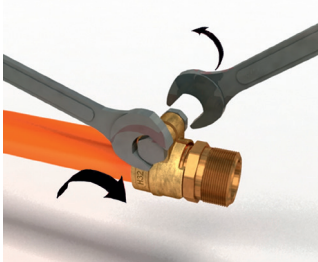

Tighten the bolt until both clamping ring halves do reach/touch each other.

PRESSURE TEST:

- A pressure test according to the method shown on page 11 is mandatory

Installation Instructions

1.6 Shrink End Cap

01

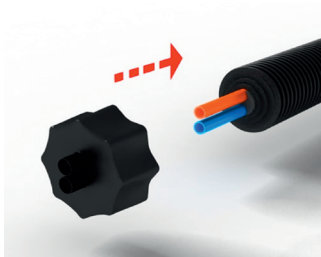

Dismantle the jacket pipe and slide the shrink cap on the jacket pipe.

02

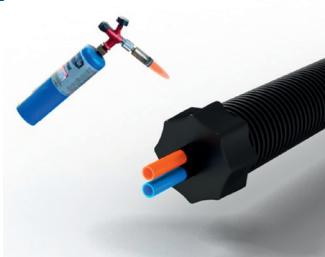

Heat softly the shrink cap both at the end of the medium and jacket pipe.

03

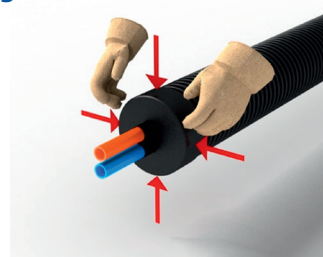

Press the shrink cap on the medium and jacket pipe. Use protective gloves

04



Once the shrink cap is cooled down, the pre-insulated pipe is water-proof.

ATTENTION:

- To prevent ingress of (ground) water, the EN 15632-3 standard prescribes the usage of Shrink End Caps to seal the non-bonded system layers at underground connections. Failing to do so involves a genuine damage risk.

Installation Instructions

1.7 Straight Insulation Sleeve

01

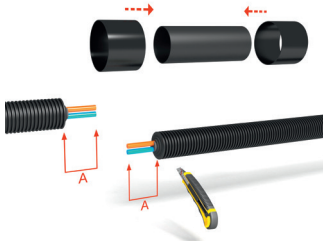

Remove carefully the jacket pipe and insulation layers to avoid damaging the medium pipe. The length of the naked medium pipe is marked with A. The length is depending on the diameter of the carrier pipe.

Ø 25 up to 63 mm -> A = 14 cm

02

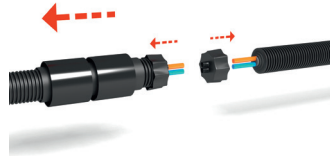

Slide the straight covering jacket pipe including two shrink sleeves over the main pre-insulated jacket pipe, and put on the shrink end caps.

03

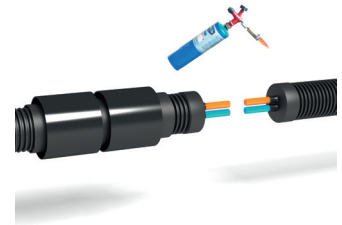

Install the shrink end caps by softly heating. Press the shrink end caps on the medium and jacket pipe. Use protective gloves.

04

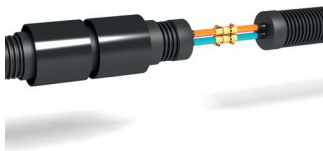

Install connector(s) according to the mounting instructions of the PE-X terminal connectors.

05

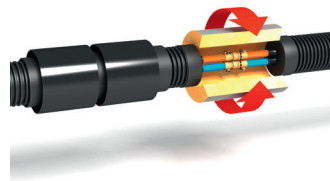

Wrap the rockwool around the connectors and fix with self-adhesive tape. (tape not supplied)

06



Slide over the straight covering jacket pipe, until both ends of the pre-insulated pipe are covered. Then slide over both shrinking sleeves, each of them covering half straight covering pipe and half jacket pipe.

07

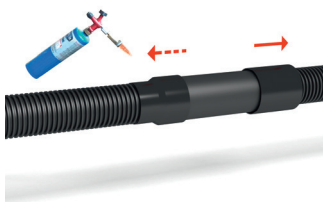

Heat up softly both shrink sleeves and press using protective gloves.

08



Both shrink sleeves are installed and became a waterproof connection.

ATTENTION:

- Separately order the appropriate size Shrink end Caps for your specific pre-insulated pipe system.
- A pressure test according to the method shown on page 11 is mandatory before closing the insulation kits.

Heat Loss Tables

The heat loss of a pre-insulated piping system is determined by the driving temperature difference ΔT between the operating temperature of the heating medium inside the medium pipe(s), and the ground temperature in the immediate neighbourhood of the buried pipe.

Depending on the selected pipe configuration, the ΔT can be calculated as following:

$$\Delta T = \frac{(T_v + T_r) - T_o}{2}$$

U-values enable easy heat loss determination, as a function of the driving temperature difference ΔT .

The corresponding heat loss per meter of pipe length [W/m] is calculated by multiplying the U-value of the subject pre-insulated pipe system with the applicable ΔT .

The table below shows the heat loss for a range of standard temperature differences.

Double Heating

U-value [W/(mK)]	Pipe Diameter mm	Heat Loss [W/m] for indicated Δt , per meter length of pre-insulated Double pipe								
		10°C	20°C	30°C	40°C	50°C	60°C	70°C	80°C	90°C
0,221	25mm	2,21	4,42	6,63	8,84	11,05	13,26	15,47	17,68	19,89
0,262	32mm	2,62	5,24	7,86	10,48	13,10	15,72	18,34	20,96	23,58

For pipe systems, heat loss is expressed in Watts per unit length of pipe. For our pre-insulated pipe systems, this is the heat flowing from the hotter inner medium-carrying PE-Xa pipes to the colder earth surrounding the outer protective HDPE jacket, and this at a rate determined by the temperature difference ΔT .

The thermal performance of a pre-insulated pipe system is, for equivalent materials and under comparable operating conditions, primarily a function of the insulation thickness.

Using the calculated driving temperature difference ΔT as an entrance, the heat loss per meter of pre-insulated pipe can be read from the corresponding lines in the graph to the right.

Calculation method for the driving temperature difference ΔT can be seen above.

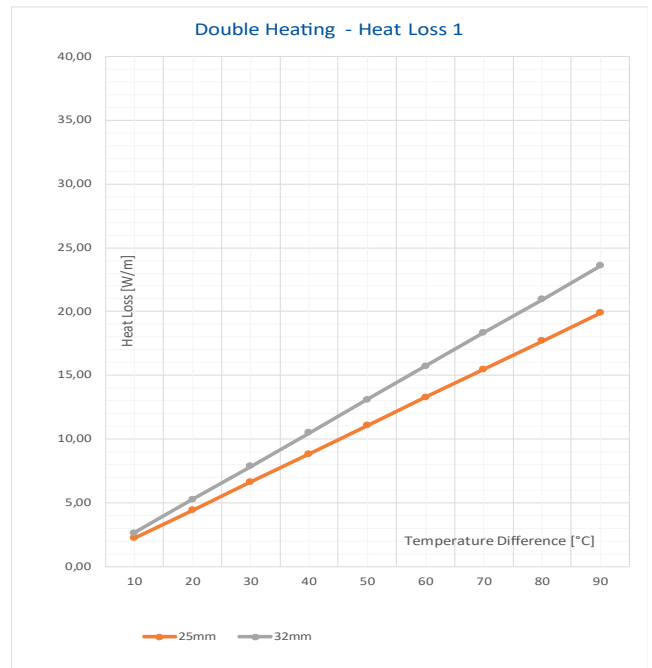

Pressure Testing

The pressure test procedure is mandatory before backfilling or concealing any pipework

Prior to concealing, fill the finished pipework with water, taking care to avoid air locks. The pressure test must be conducted in three parts, starting with the preliminary test, followed by the main test.

1. **Preliminary test:** The preliminary test involves applying a test pressure equal to 1.5 times the admissible operating pressure. This pressure must be regenerated twice within the space of 30 minutes at intervals of 10 minutes. Following a test period of another 30 minutes, the test pressure must not have fallen by more than 0.6 bar. Leakages must not occur at any points in the system being tested.

2. **Main test.** The main test has to be conducted immediately after the preliminary test. The test takes 2 hours. At the end of this period, the test pressure recorded after the preliminary test must not have fallen by more than 0.2 bar. Leakages must not occur at any point in the system being tested..

Leakage testing

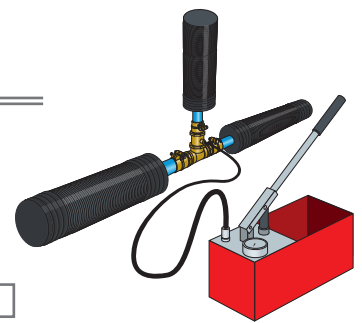
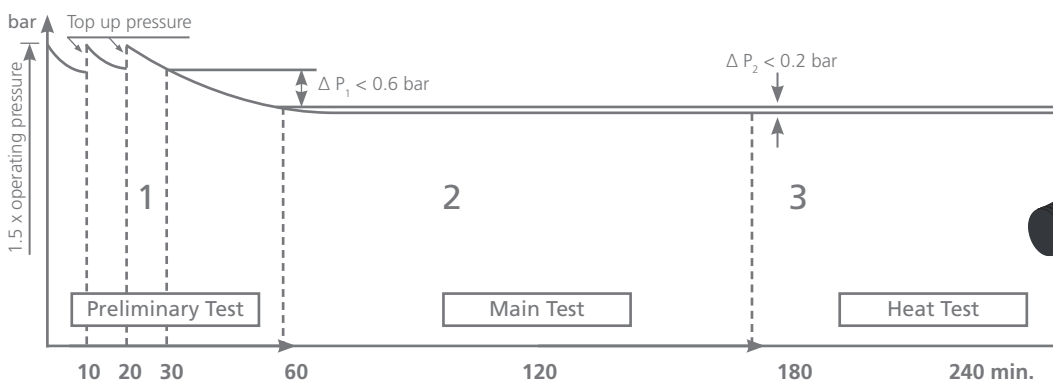

1 Preliminary test		Bar / psi	2 Main test		Bar / psi
1.1	Operating pressure x 1.5		2.1.1	Beginning (hh:mm)	:
1.2	After 10 min. (restore 1.1)		2.1.2	End (hh:mm)	:
1.3	After 20 min. (restore 1.1)		2.2	Test pressure	
1.4	After 30 min.		2.3	After 120 min.	
1.5	After 60 min. admissible pressure drop < 0.6 bar		2.4	Remarks admissible pressure drop < 0.2 bar	

ATTENTION:

- Always pressure test the completed pipe work before concealing.
- The conscientious execution and documentation of the standardised pressure test for the entire piping system is a requirement. Failing to do so involves a genuine damage risk.

Pre-Insulated Piping for Heating & Cooling and Hot & Cold Water Supply

Product Installation Guide



Polypipe Ulster
Dromore Road
Lurgan, Craigavon
Co. Armagh
BT66 7HL
United Kingdom
Tel: +44 (0)28 38 881270
Fax: +44 (0)28 38 882344

Polypipe Building Products
2410 London Road
Mount Vernon
Glasgow
G32 8XZ
United Kingdom
Tel: +44 (0)141 778 8822
Fax: +44 (0)141 778 2703

Polypipe Building Products
Broomhouse Lane
Edlington
Doncaster
DN12 1ES
Tel +44 (0)1709 770000
Email info@polypipe.com

